

**DUFFILL WATTS & KING LTD**  
 CONSULTING CIVIL & STRUCTURAL ENGINEERS  
 Dunedin P.O. Box 5289 Ph 77-133 Invercargill P.O. Box 576 Ph 83049  
 Balclutha P.O. Box 220 Phone 1425  
 Cromwell P.O. Box 82 Phone 96

**NASEBY BOROUGH COUNCIL**

**SANITARY SEWERAGE RETICULATION SEWER LAYOUT**

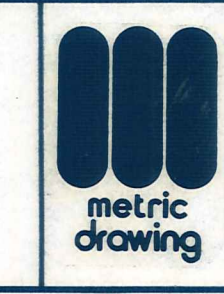

DATUM  
M.S.L.  
ORIGIN  
TRIG X

AMENDMENTS			
NO.	BY	DATE	Appvd.

NAME	DATE
Surveyed B.T. Kinston	Oct '76
Drawn " " " "	" " "
Calculations " " " "	" " "
Traced A.H. Moore	Oct '76
Checked " " " "	" " "
Approved <i>Chamberlain</i>	Dec '76

JOB NO.	8 2 6 2	Sheet No	1
File 26/3/3	LB 326 327	F.B.	of 18 shts



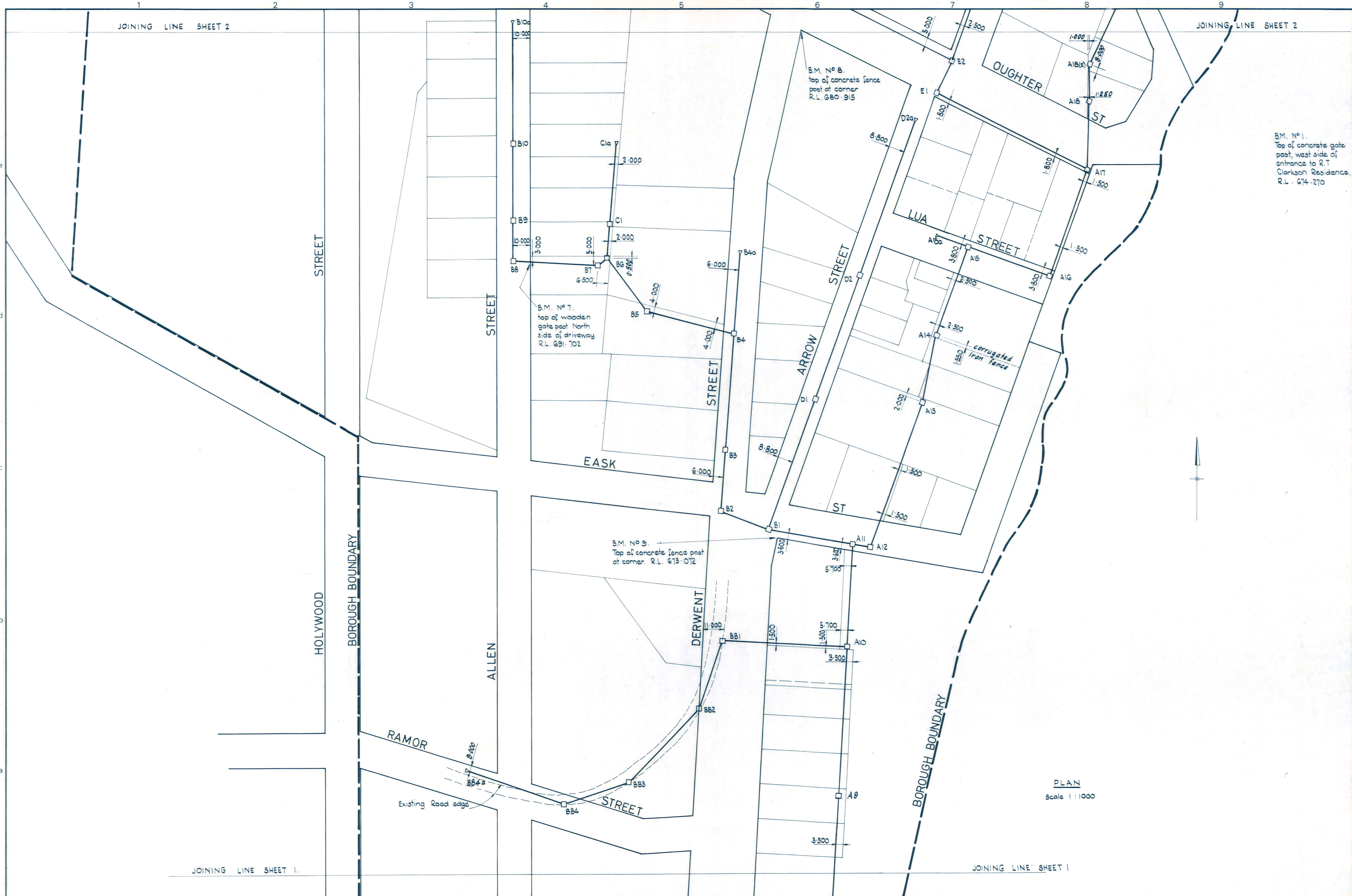

PLAN  
Scale 1:1000

B.M. No 1.  
Top of concrete gate  
post, west side of  
entrance to R.T.  
Clarkson Residence.  
R.L. 674.270

**DUFFILL WATTS & KING LTD**  
CONSULTING CIVIL & STRUCTURAL ENGINEERS  
Dunedin P.O. Box 5289 Ph 77-133 Invercargill P.O. Box 576 Ph 83049  
Balclutha P.O. Box 220 Phone 1425  
Cromwell P.O. Box 82 Phone 96

**NASEBY  
BOROUGH  
COUNCIL**

**SANITARY SEWERAGE RETICULATION  
SEWER LAYOUT**

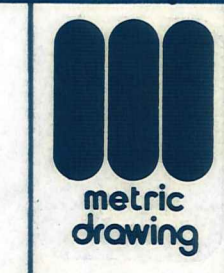

DATUM  
M. S. L.  
ORIGIN  
TRIG X

AMENDMENTS			NAME	DATE
NO.	BY	DATE		
			B.T. Kingston	Oct '76
			"	"
			"	"
			A.H. Moore	Oct '76

JOB NO.	Sheet No
8 2 6 2	2
File 26/3/3	of 18 sheets
L.B. 327	F.B.



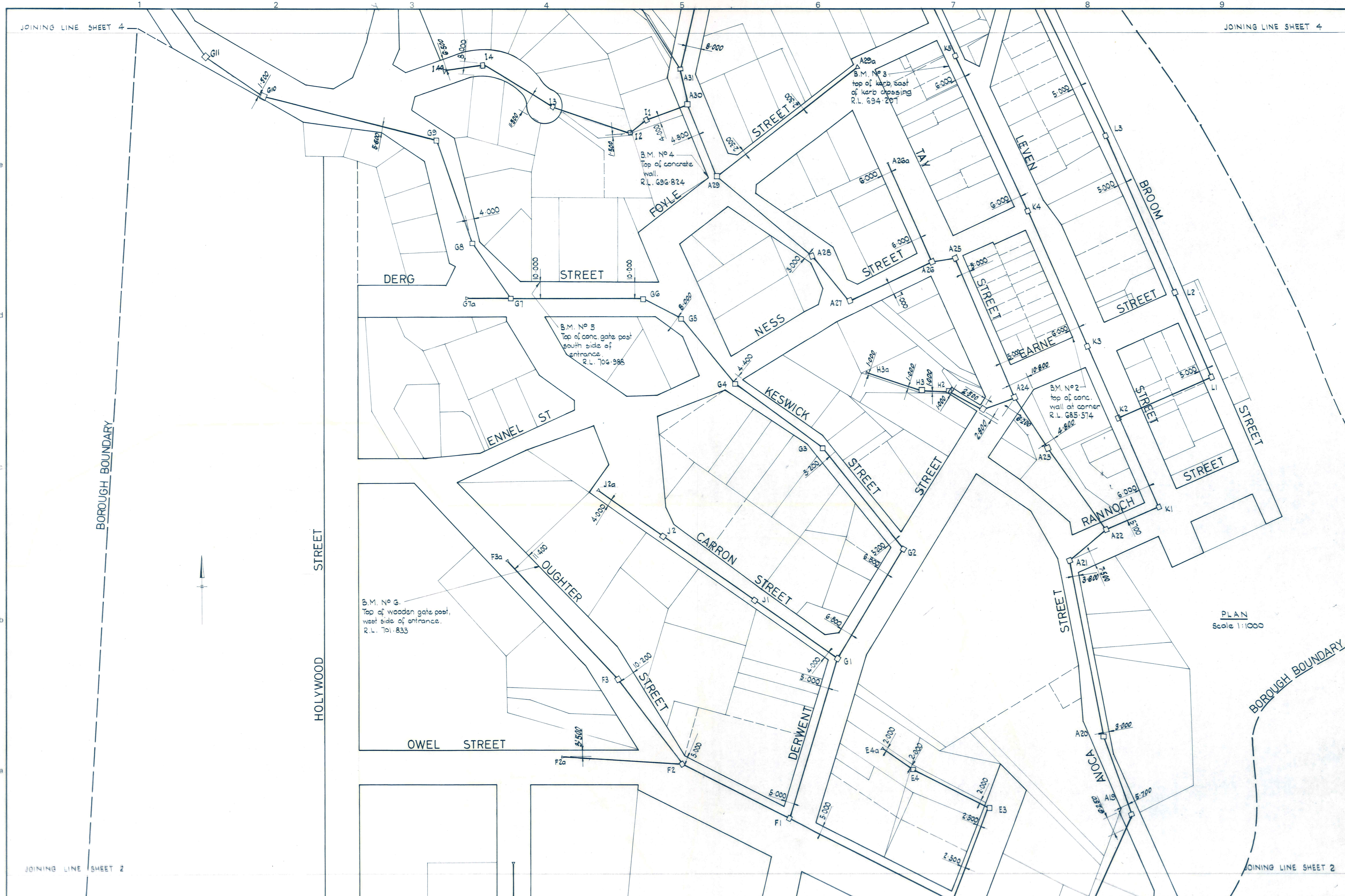

INCHES 0 1 2 3 4 5 6 7 8 9 10 11 12

PLAN  
Scale 1:1000

**DUFFILL WATTS & KING LTD**  
CONSULTING CIVIL & STRUCTURAL ENGINEERS  
Head Office: P.O. Box 8688, Ph. 77-133, Invercargill, P.O. Box 576, Ph. 83049  
Blanchard: P.O. Box 250, Phone 1425  
Visitors: P.O. Box 82, Phone 95

**NASEBY BOROUGH COUNCIL**

**SANITARY SEWERAGE RETICULATION SEWER LAYOUT**

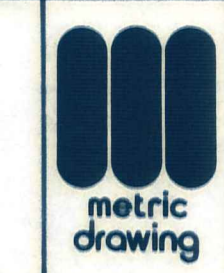

DATUM  
M.S.L.  
ORIGIN  
TRIG X

AMENDMENTS		
NO.	BY	DATE

NAME	DATE
Surveyed B.T. Kinston	Oct '76
Drawn " "	" "
Calculations " "	" "
Traced A.H. Moore	Oct '76
Checked " "	" "
Approved " "	Dec '76

JOB NO.	Sheet No
8 2 6 2	3
File 26/3/3	of 18 sheets
L.B. 327	F.B.



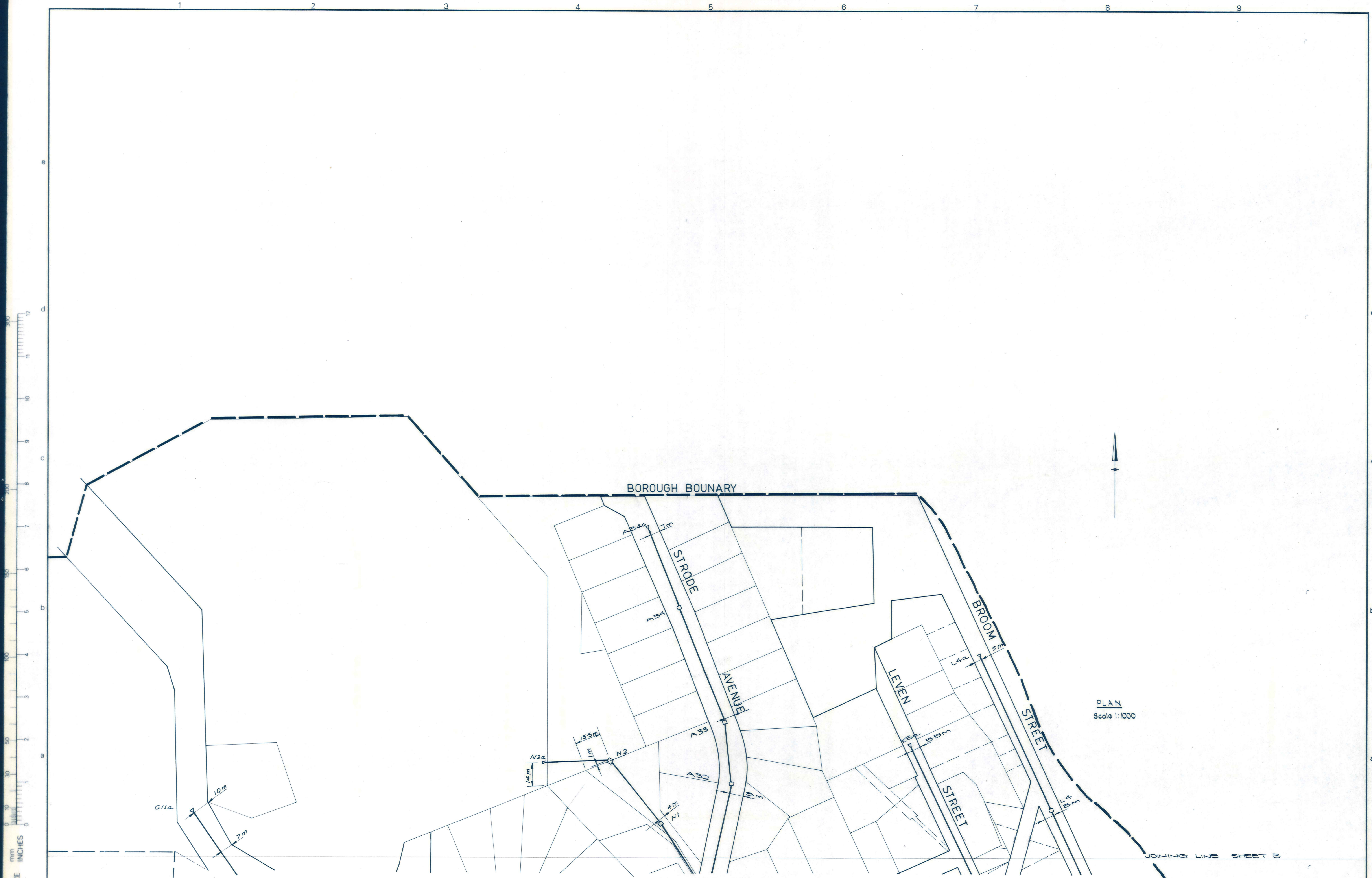

ORIGINAL SIZE INCHES  
 0 10 20 30 40 50 60 70 80 90 100 110 120  
 mm

PLAN  
 Scale 1:1000

JOINING LINE SHEET 3

**DUFFILL WATTS & KING LTD**  
 CONSULTING CIVIL & STRUCTURAL ENGINEERS  
 Dunedin P.O. Box 5269 Ph. 77-133 Invercargill P.O. Box 576 Ph. 83049  
 Balclutha P.O. Box 220 Phone 1425  
 Cromwell P.O. Box 82 Phone 96

**NASEBY  
 BOROUGH  
 COUNCIL**

**SANITARY SEWERAGE RETICULATION  
 SEWER LAYOUT**

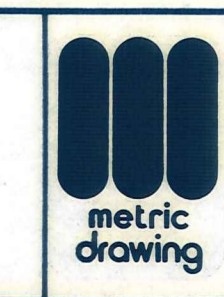

**DATUM**  
 M.S.L.  
**ORIGIN**  
 TRIG X

AMENDMENTS				Appvd.	NAME	DATE
NO.	BY	DATE				
					BRUNSTON	Oct '76
					"	"
					"	"
					EVERWOOD	OCT '81
					(Chamberlain)	Dec '76

Job No.	8 2 6 2	Sheet No.	4
File	26/3/3	L.B.	326 327
F.B.			



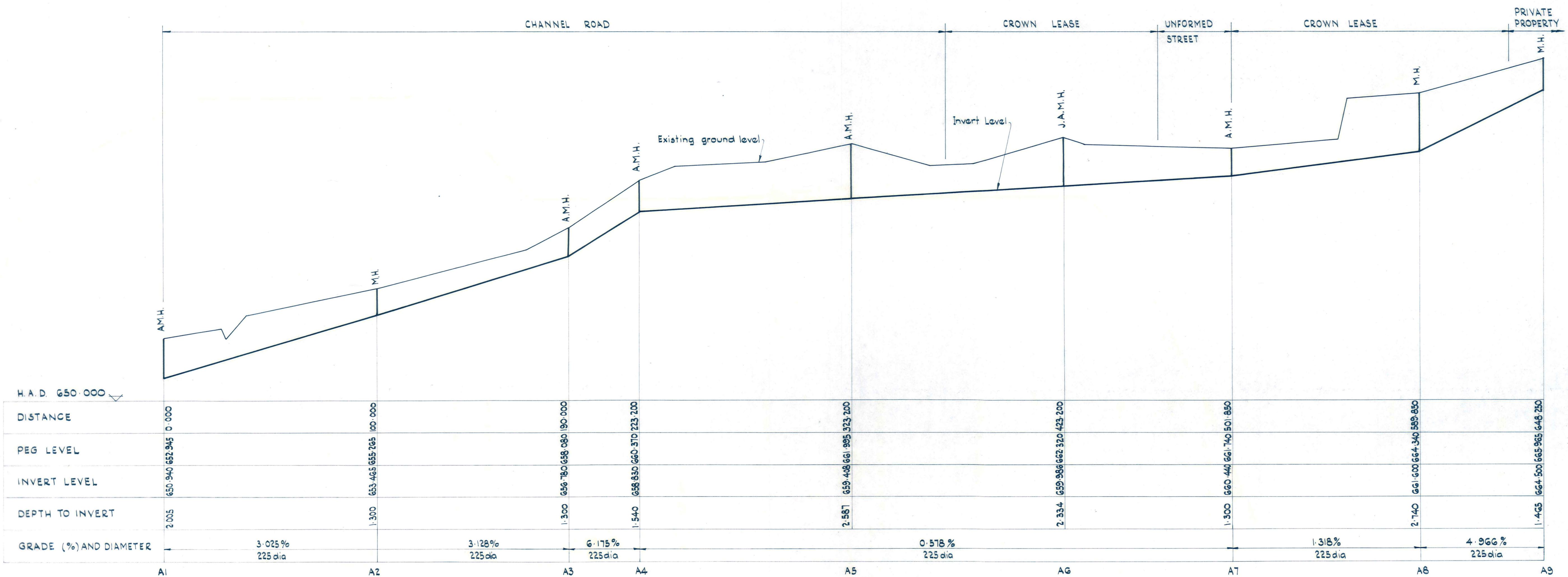
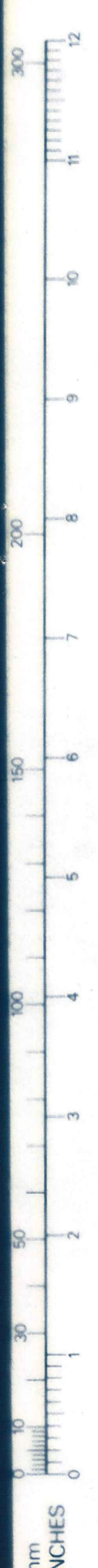

	A1	A2	A3	A4	A5	A6	A7	A8	A9
H.A.D. 650.000									
DISTANCE	650.940	652.945	658.000	660.223	666.323	662.320	664.501	664.340	664.250
PEG LEVEL									
INVERT LEVEL									
DEPTH TO INVERT	2.005	1.300	1.300	1.540	2.581	2.334	1.300	2.740	1.405
GRADE (%) AND DIAMETER		3.025% 225 dia	3.128% 225 dia	6.175% 225 dia		0.578% 225 dia		1.316% 225 dia	4.966% 225 dia

**SANITARY SEWER PROFILES**

Scales - Horizontal 1:1000  
Vertical 1:100

**DUFFILL WATTS & KING LTD**  
CONSULTING CIVIL & STRUCTURAL ENGINEERS  
Dunedin P.O. Box 5269 Ph. 77-133 Invercargill P.O. Box 576 Ph. 83049  
Balclutha P.O. Box 220 Phone 1425  
Cromwell P.O. Box 82 Phone 96

**NASEBY  
BOROUGH  
COUNCIL**

**SANITARY SEWERAGE RETICULATION  
SEWER PROFILES**



DATUM  
ORIGIN

AMENDMENTS			Appvd.
NO.	BY	DATE	

NAME	DATE
Surveyed B.T. Kinaston	Oct '76
Drawn " "	" "
Calculations " "	" "
Traced A.H. Moore	Oct '76
Checked " "	" "
Approved Chamberlain	Dec '76

JOB NO.	8 2 6 2	Sheet No	5
File 26/3/3	L.B. 326 327	of 18 shts	F.B.



300  
200  
150  
100  
50  
0  
0  
10  
20  
30  
40  
50  
60  
70  
80  
90  
100  
110  
120

mm  
INCHES

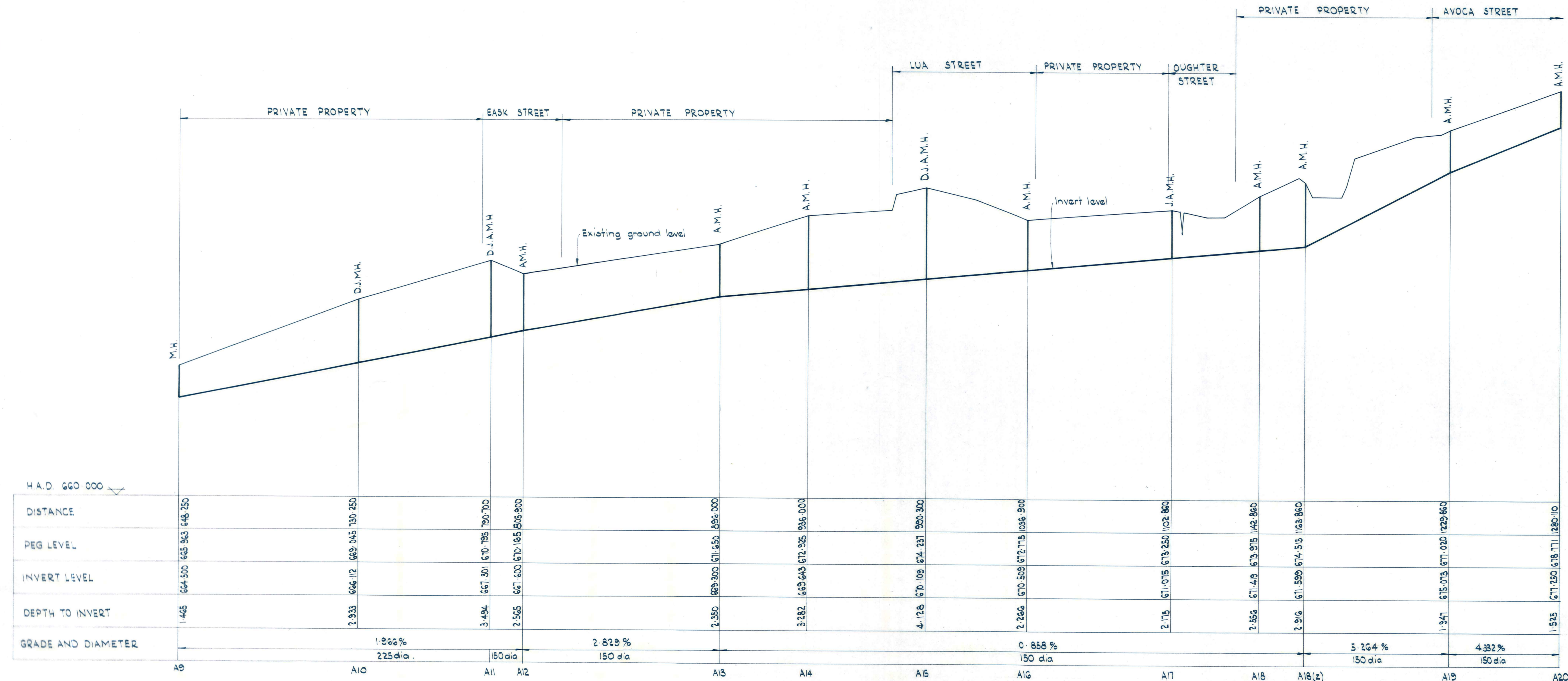

SANITARY SEWER PROFILES  
 Scales: Horizontal 1:1000  
 Vertical 1:100

**DUFFILL WATTS & KING LTD**  
 CONSULTING CIVIL & STRUCTURAL ENGINEERS  
 Dunedin P.O. Box 5289 Ph. 77-133 Invercargill P.O. Box 576 Ph. 83049  
 Balclutha P.O. Box 220 Phone 1425  
 Cromwell P.O. Box 82 Phone 96

**NASEBY BOROUGH COUNCIL**

**SANITARY SEWERAGE RETICULATION SEWER PROFILES**



DATUM  
M.S.L.  
ORIGIN  
TRIG X.

AMENDMENTS		
NO.	BY	DATE

NAME	DATE
Surveyed B.T. Kinaston	Oct '76
Drawn " "	" "
Calculations " "	" "
Traced A.H. Moore	Oct '76
Checked " "	" "
Approved " "	Dec '76

JOB NO. **8262**  
 Sheet No. **6**  
 of 18 sheets  
 File 26/3/3 L.B. 326 327 F.B.

ORIGINAL SIZE



300  
200  
100  
0  
mm  
INCHES  
ORIGINAL SIZE

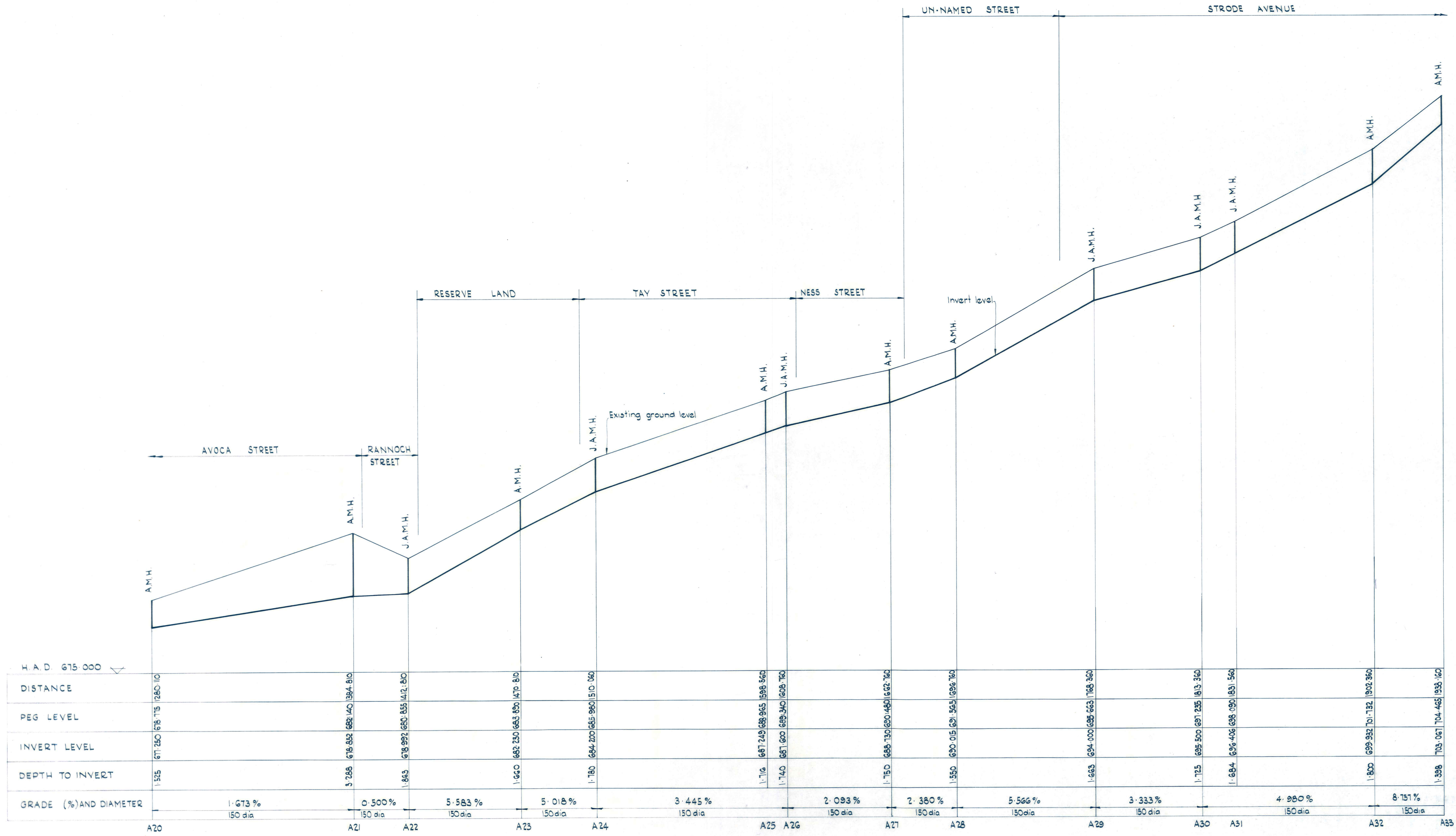

	A20	A21	A22	A23	A24	A25	A26	A27	A28	A29	A30	A31	A32	A33
H.A.D. 675 000														
DISTANCE	1260.10	1364.810	1412.800	1470.810	1510.000	1598.560	1608.760	1662.760	1696.760	1768.360	1813.360	1831.560	1902.360	1938.160
PEG LEVEL	671.250	675.775	682.140	683.850	684.200	688.965	689.940	690.460	691.565	694.000	695.500	696.090	699.932	704.465
INVERT LEVEL	671.250	675.852	680.555	682.250	684.200	687.249	687.600	688.730	690.015	694.000	695.500	696.090	699.932	703.001
DEPTH TO INVERT	1.525	3.266	1.863	1.660	1.780	1.716	1.740	1.750	1.550	1.663	1.725	1.684	1.800	1.398
GRADE (%) AND DIAMETER		1.673 % 150 dia	0.500 % 150 dia	5.583 % 150 dia	5.018 % 150 dia	3.445 % 150 dia	2.093 % 150 dia	2.380 % 150 dia	5.566 % 150 dia	3.333 % 150 dia	4.980 % 150 dia		8.151 % 150 dia	

PROFILES  
Scales - Horizontal 1:1000  
Vertical 1:100

**DUFFILL WATTS & KING LTD**  
CONSULTING CIVIL & STRUCTURAL ENGINEERS  
Dunedin P.O. Box 5288 Ph 77-133 Invercargill P.O. Box 576 Ph 83049  
Balclutha P.O. Box 220 Phone 1425  
Cromwell P.O. Box 82 Phone 96

**NASEBY BOROUGH COUNCIL**

**SANITARY SEWERAGE RETICULATION  
SEWER PROFILE**



DATUM  
M.S.L.  
ORIGIN  
TRIG X

AMENDMENTS			Appvd.
NO.	BY	DATE	

NAME	DATE
Surveyed	B.T. Kingston Oct '76
Drawn	" " " "
Calculations	" " " "
Traced	A.H. Moore Oct '76
Checked	" " " "
Approved	Glenclaw Dec '76

JOB NO.	8 2 6 2	Sheet No	7
		of 18 shts.	
File 26/3/3	L.B. 326 327	F.B.	



300  
200  
150  
100  
50  
30  
10  
0  
mm  
INCHES

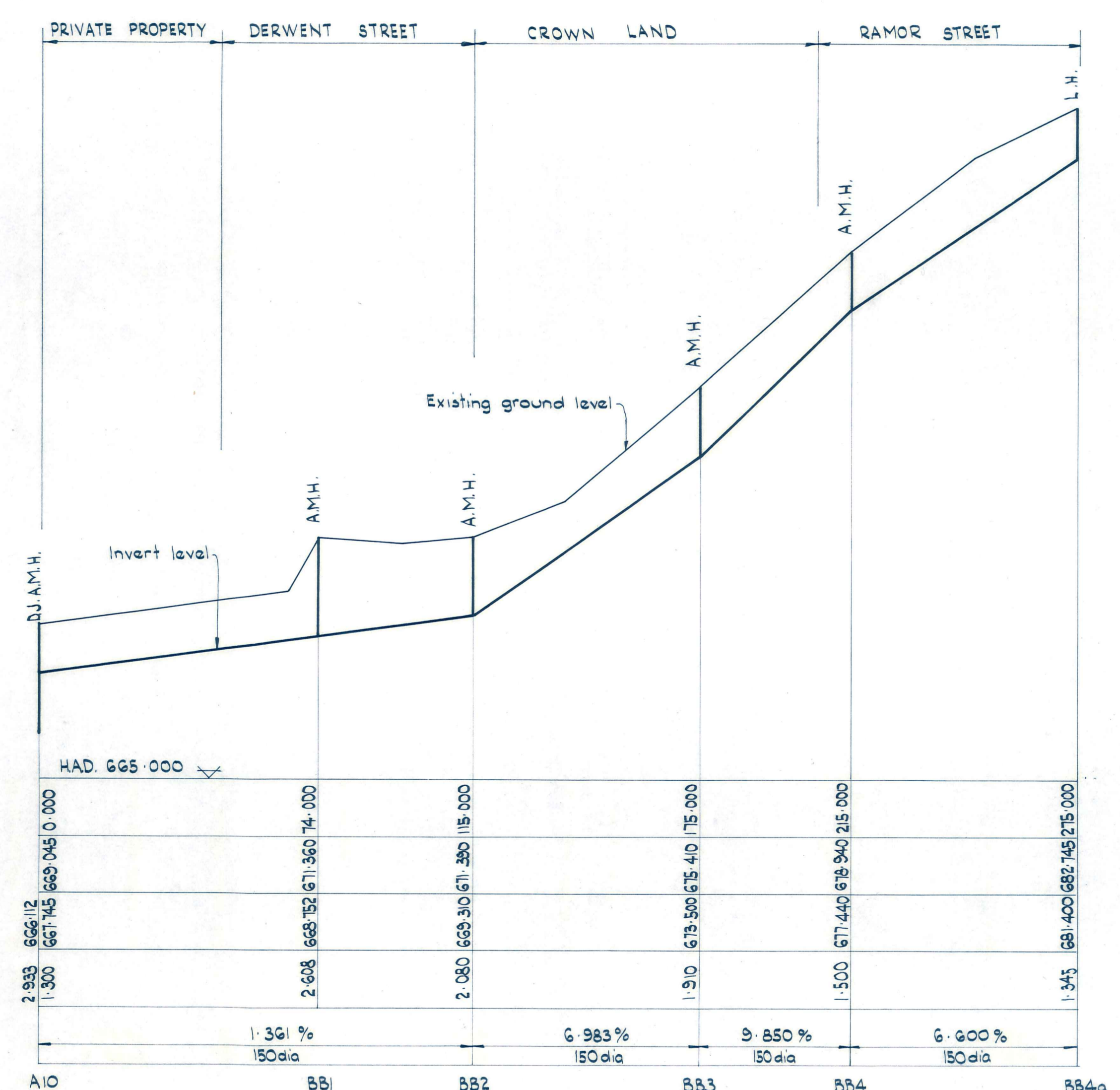
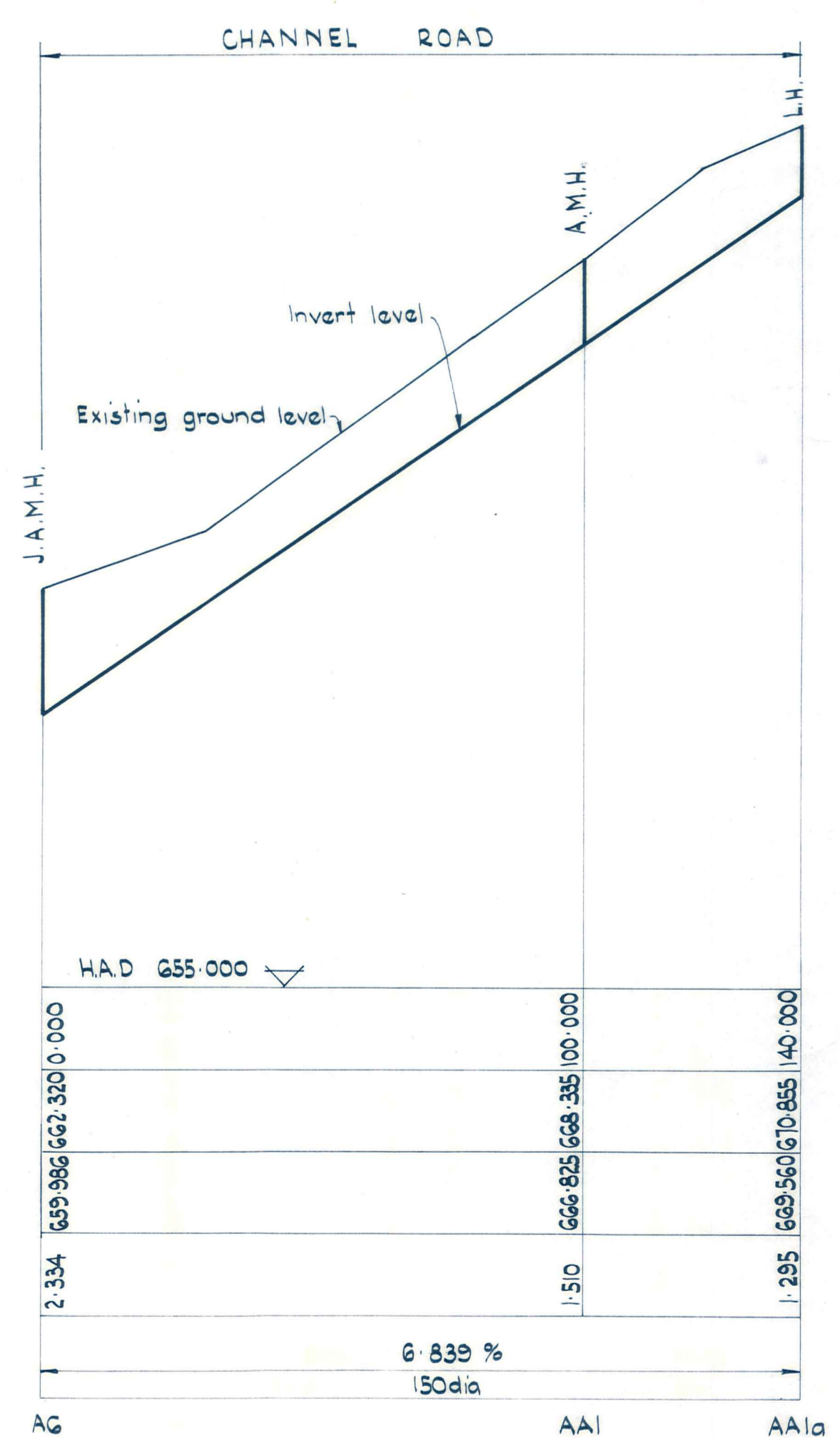
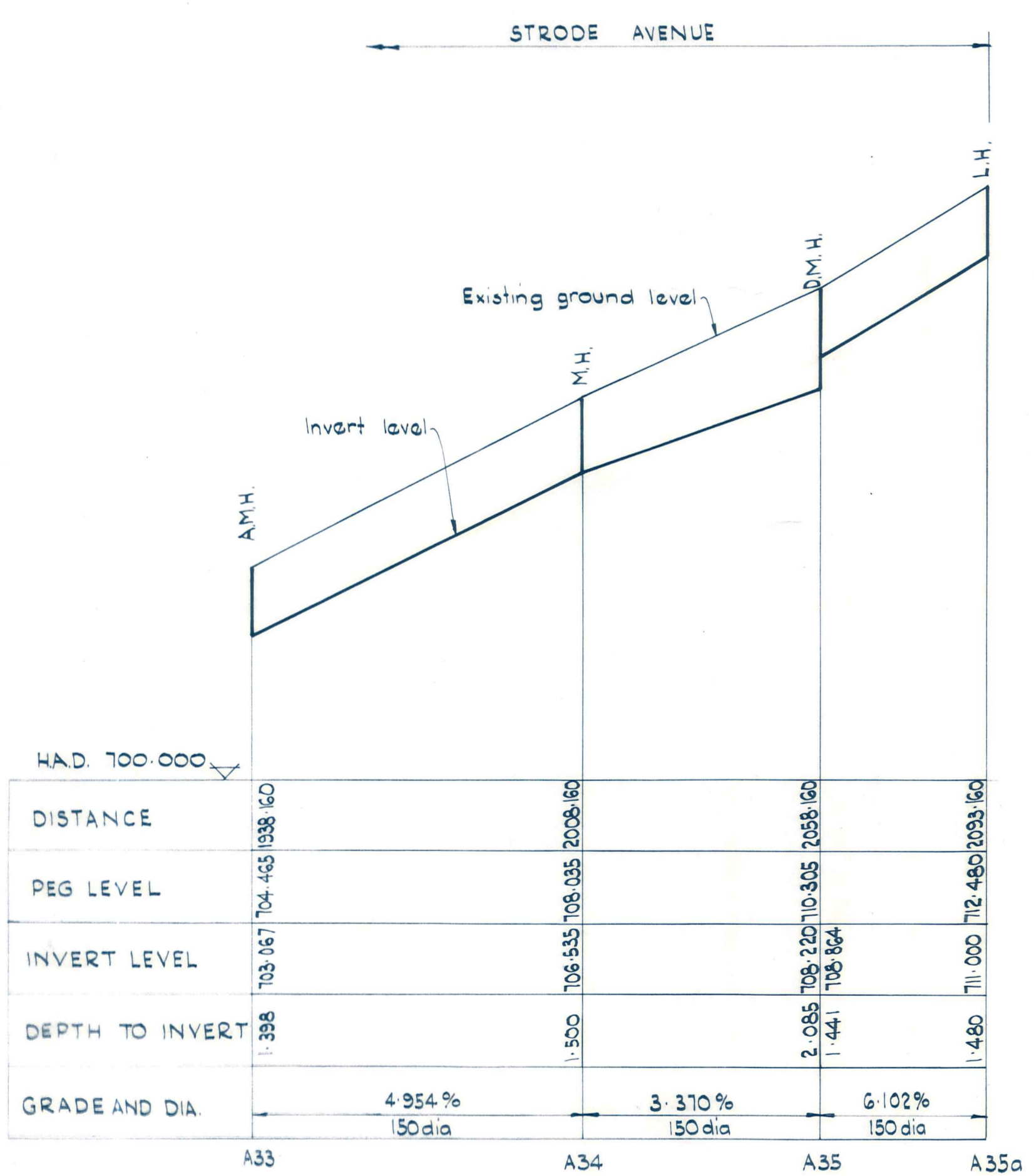

PROFILES  
Scales - Horizontal 1:1000  
Vertical 1:100

**DUFFILL WATTS & KING LTD**  
CONSULTING CIVIL & STRUCTURAL ENGINEERS  
Dunedin P.O. Box 5289 Ph. 77 133 Invercargill P.O. Box 676 Ph. 83049  
Balclutha P.O. Box 220 Phone 1425  
Dromwell P.O. Box 82 Phone 96

**NASEBY BOROUGH COUNCIL**

**SANITARY SEWERAGE RETICULATION  
SEWER PROFILES**



DATUM  
M.S.L.  
ORIGIN  
TRIG X

AMENDMENTS		
NO.	BY	DATE

NAME	DATE
B.T. Kinaston	Oct '76
A.H. Moore	Oct '76
<i>[Signature]</i>	Dec '76

JOB NO. **8262**  
Sheet No **8**  
of 18 sheets  
F.B.



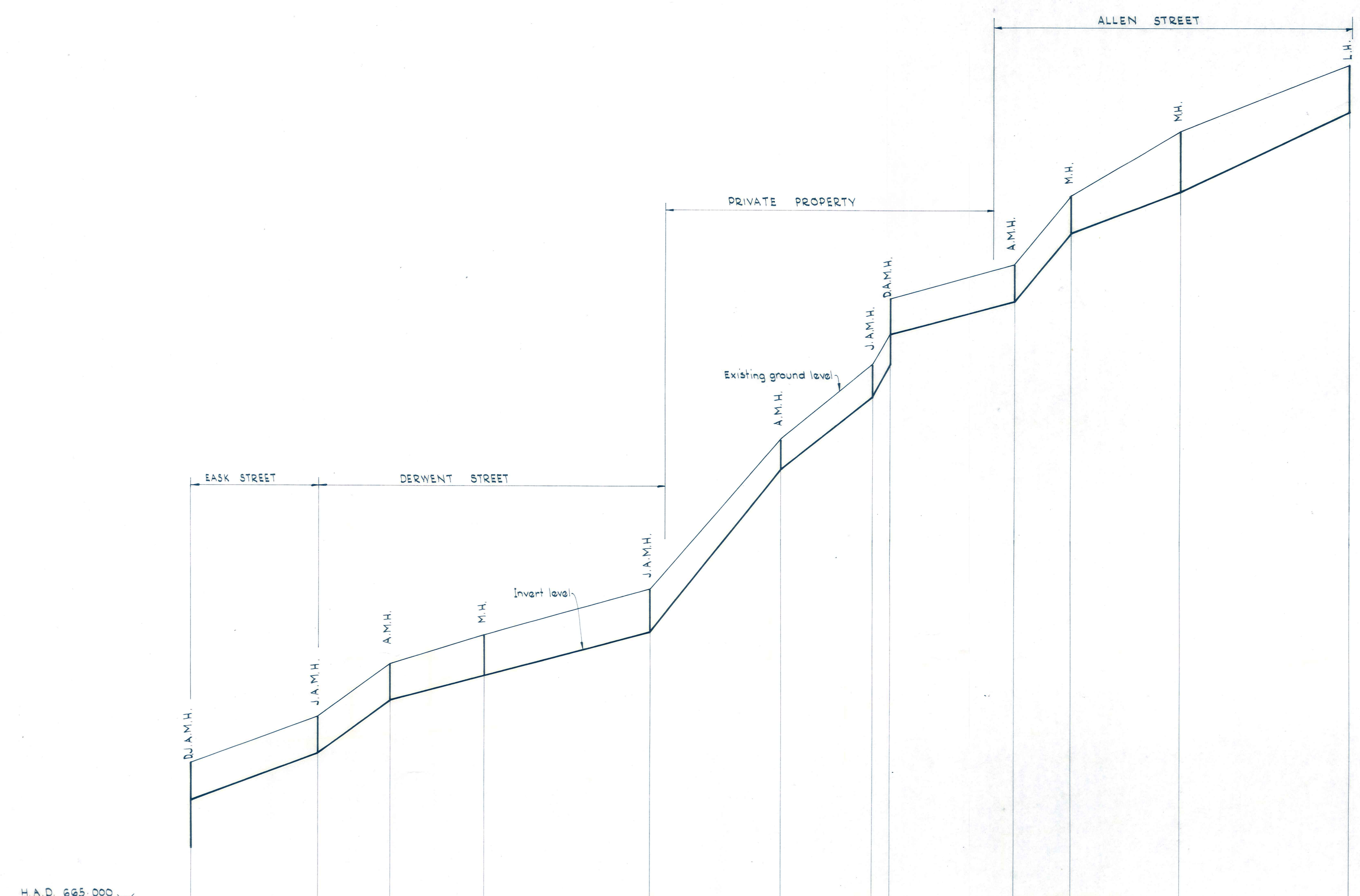
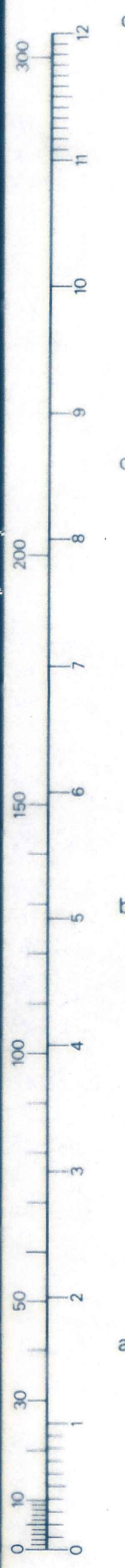

DISTANCE	PEG LEVEL	INVERT LEVEL	DEPTH TO INVERT	GRADE AND DIAMETER
3.434	667.301	667.301	1.500	3.663% 150 dia
671.200	672.715	672.715	1.515	7.283% 150 dia
674.413	676.100	676.100	1.687	2.636% 150 dia
676.200	677.915	677.915	1.715	12.593% 150 dia
685.000	684.280	684.280	1.280	7.853% 150 dia
687.245	687.245	687.245	1.300	19.01% 150 dia
687.281	688.480	688.281	2.100	2.784% 150 dia
689.900	691.395	691.395	1.485	16.298% 150 dia
694.230	694.230	694.230	1.500	3.600% 150 dia
696.890	696.890	696.890	2.540	5.410% 150 dia
698.650	698.650	698.650	1.995	

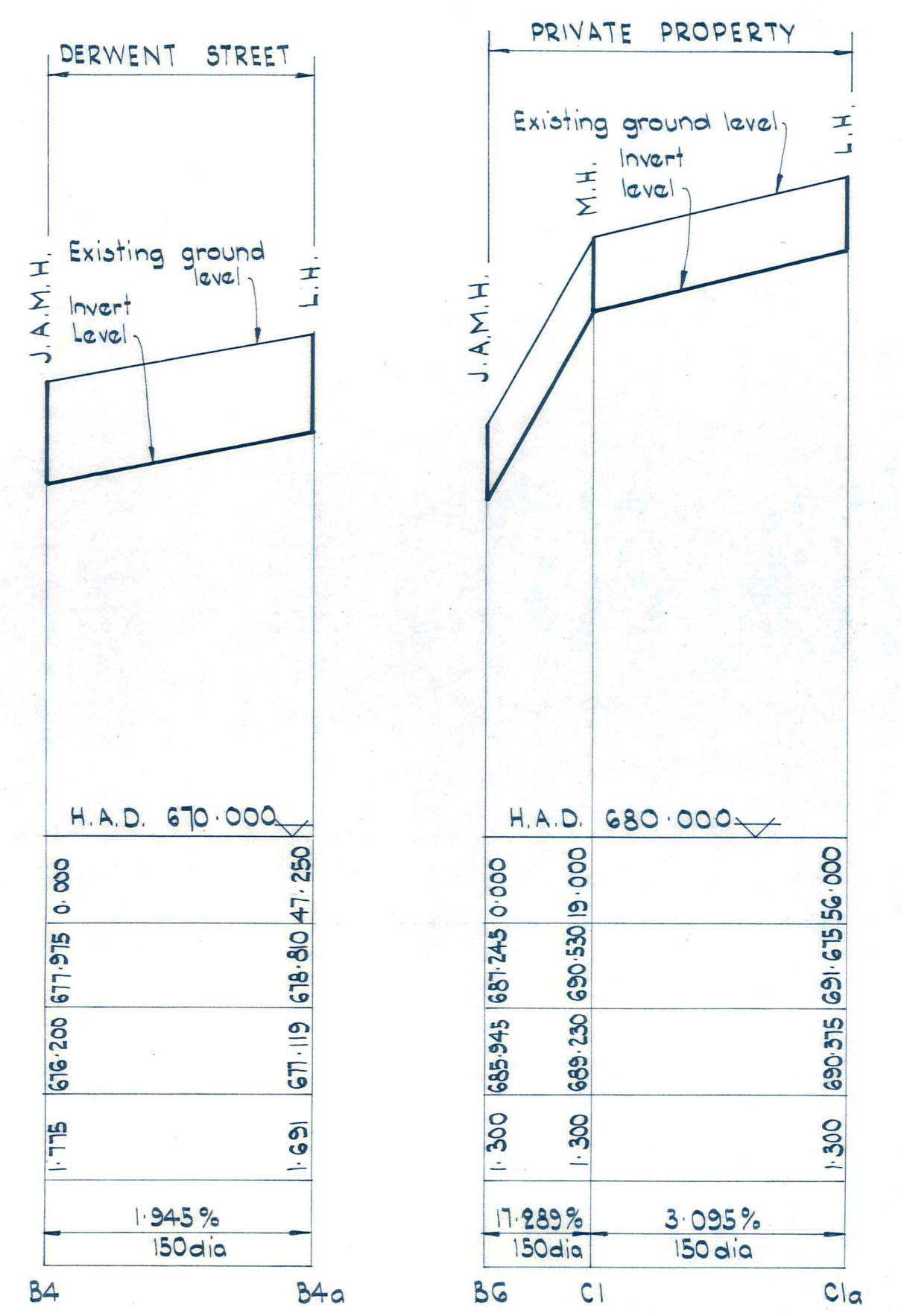

PROFILES  
Scale - Horizontal 1:1000  
Vertical 1:100

**DUFFILL WATTS & KING LTD**  
CONSULTING CIVIL & STRUCTURAL ENGINEERS  
Dunedin P.O. Box 5289 Ph. 77-133 Invercargill P.O. Box 576 Ph. 83049  
Balclutha P.O. Box 220 Phone 1425  
Cromwell P.O. Box 82 Phone 96

**NASEBY BOROUGH COUNCIL**

**SANITARY SEWERAGE RETICULATION  
SEWER PROFILES**



**DATUM**  
M.S.L.  
**ORIGIN**  
TRIG X

AMENDMENTS			
NO.	BY	DATE	Appvd.

NAME	DATE
B.T. Kinaston	Oct '76
A.H. Moore	Oct '76

JOB NO.	Sheet No
8262	9
File 26/3/3	of 18 shts
L.B. 326 327	F.B.

ORIGINAL SIZE

mm INCHES



ORIGINAL SIZE INCHES

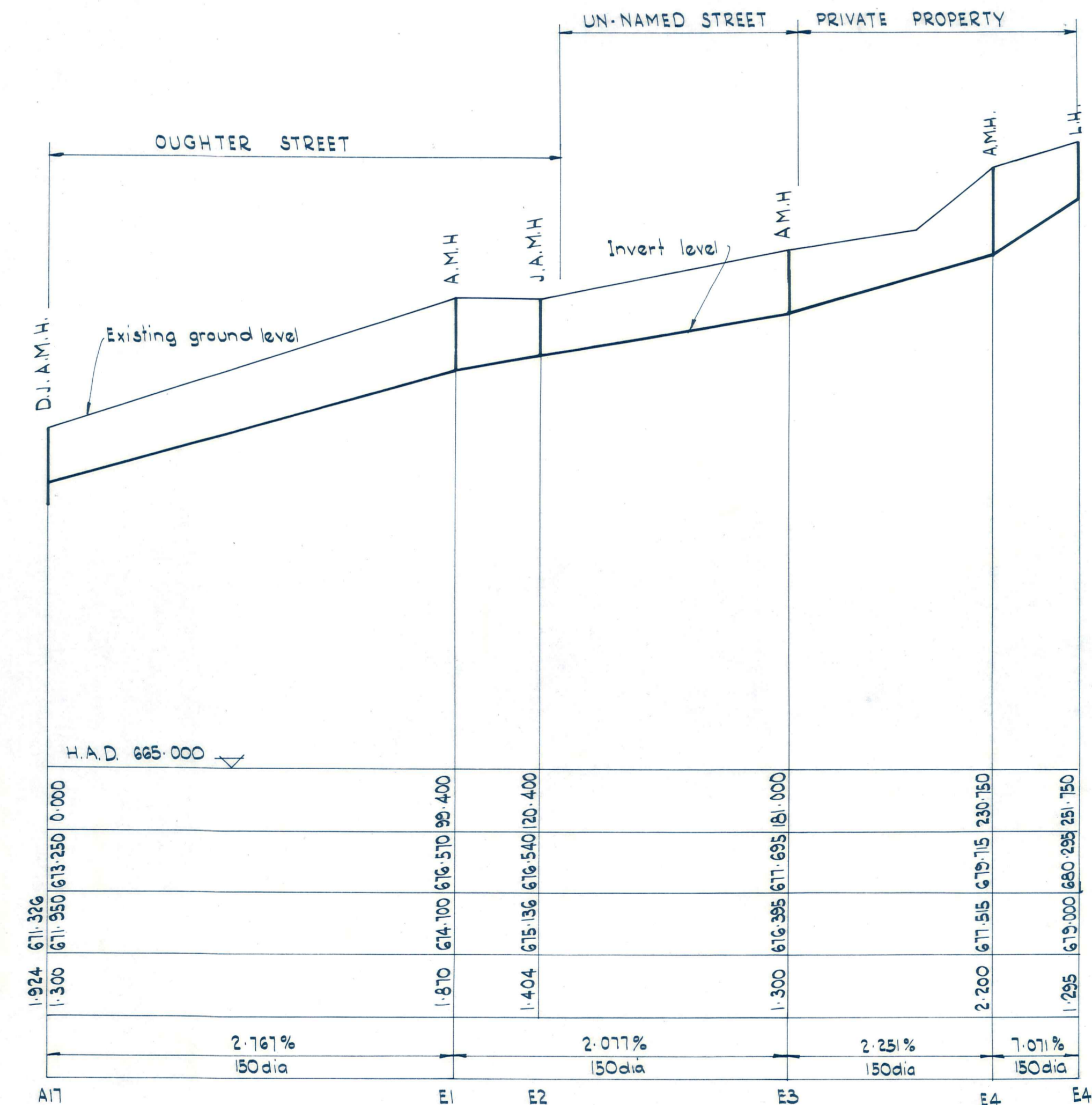
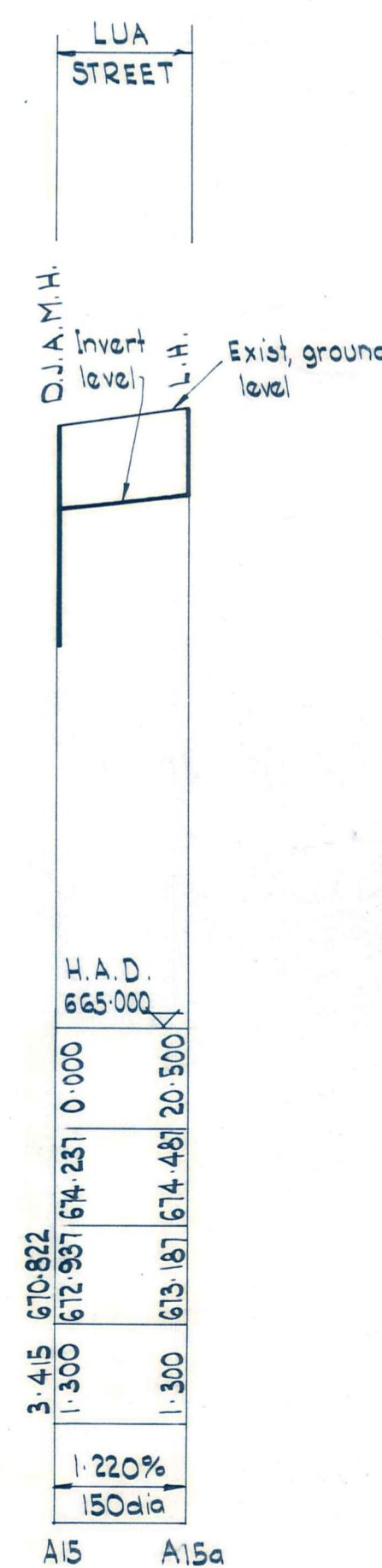
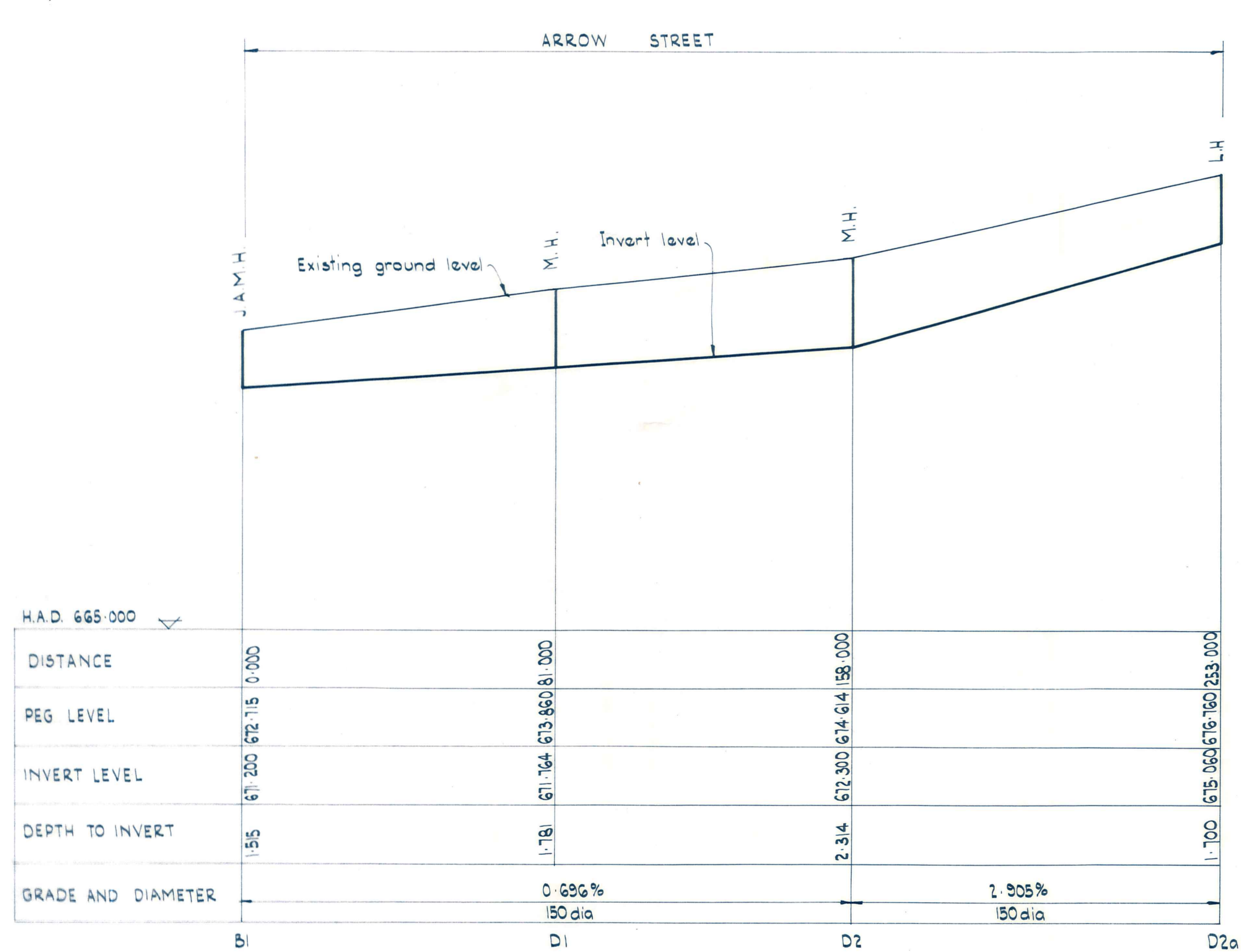

PROFILES  
 Scales Horizontal 1:1000  
 Vertical 1:100

**DUFFILL WATTS & KING LTD**  
 CONSULTING CIVIL & STRUCTURAL ENGINEERS  
 Dundee P.O. Box 5289 Ph 77-133 Invercargill P.O. Box 576 Ph 83049  
 Balclutha P.O. Box 220 Phone 1425  
 Cromwell P.O. Box 82 Phone 96

**NASEBY BOROUGH COUNCIL**

**SANITARY SEWERAGE RETICULATION  
 SEWER PROFILES**

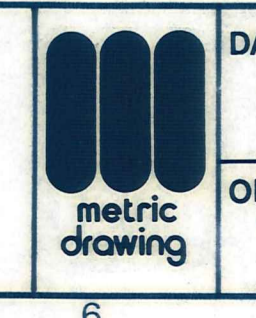

DATUM  
 M.S.L.  
 ORIGIN  
 TRIG X

AMENDMENTS			NAME		DATE	
NO.	BY	DATE				
			Appvd	Surveyed	B.T. Kingston	Oct '74
				Drawn	"	"
				Calculations	"	"
				Traced	A.H. Moore	Oct '74
				Checked		
				Approved	Chamberlain	Dec '76

JOB NO.		Sheet No	
8 262		10	
		of 16 shts	
File 26/3/3	L.B. 326 327	F.B.	



ORIGINAL SIZE mm INCHES  
 0 10 20 30 40 50 60 70 80 90 100 150 200 300  
 0 1 2 3 4 5 6 7 8 9 10 11 12

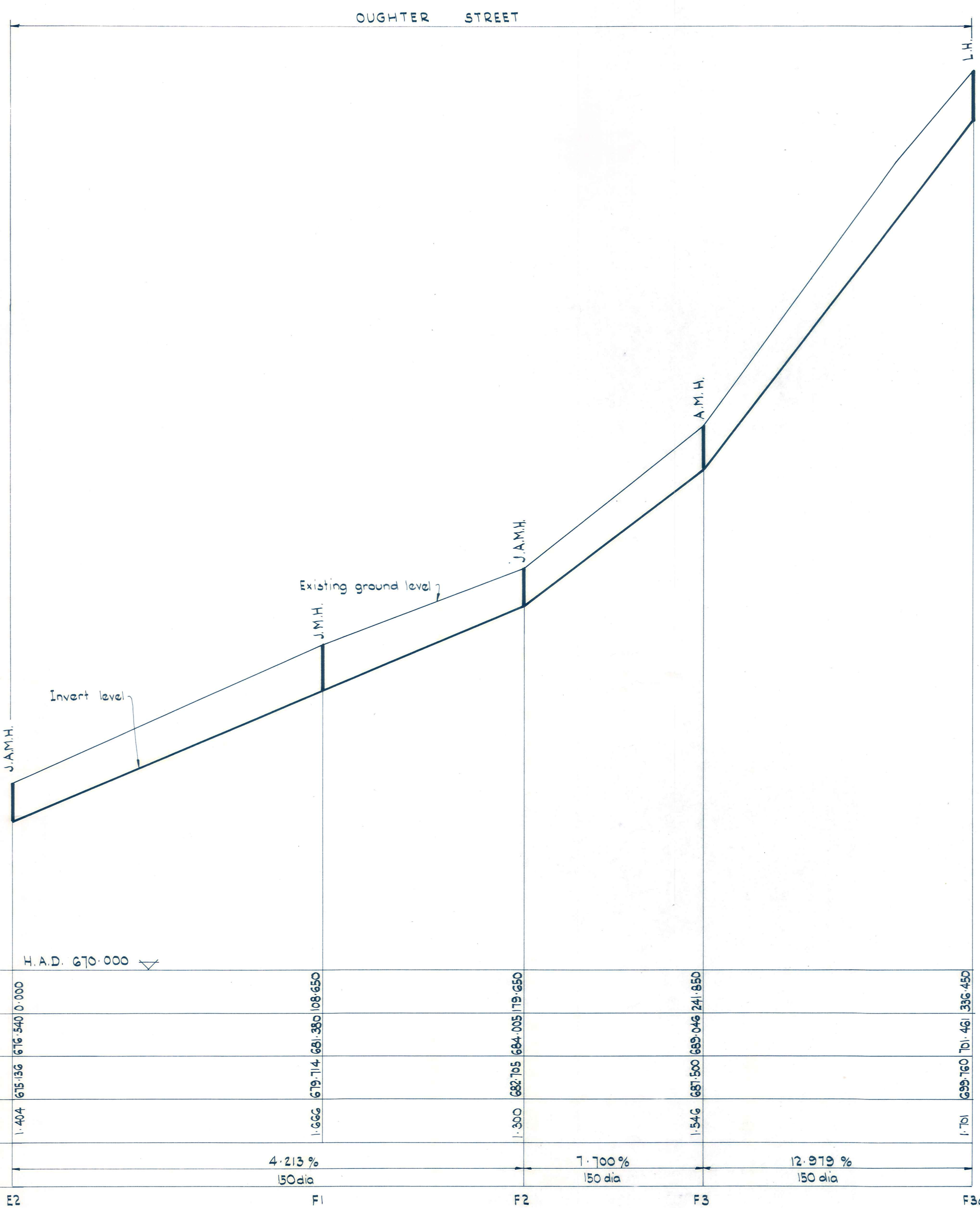

	E2	F1	F2	F3	F3a
DISTANCE					
PEG LEVEL	676.540	681.335	684.005	685.046	691.461
INVERT LEVEL	675.136	679.714	682.705	681.500	689.760
DEPTH TO INVERT	1.404	1.621	1.300	1.546	1.701
GRADE AND DIAMETER		4.213 % 150 dia	7.700 % 150 dia	12.919 % 150 dia	

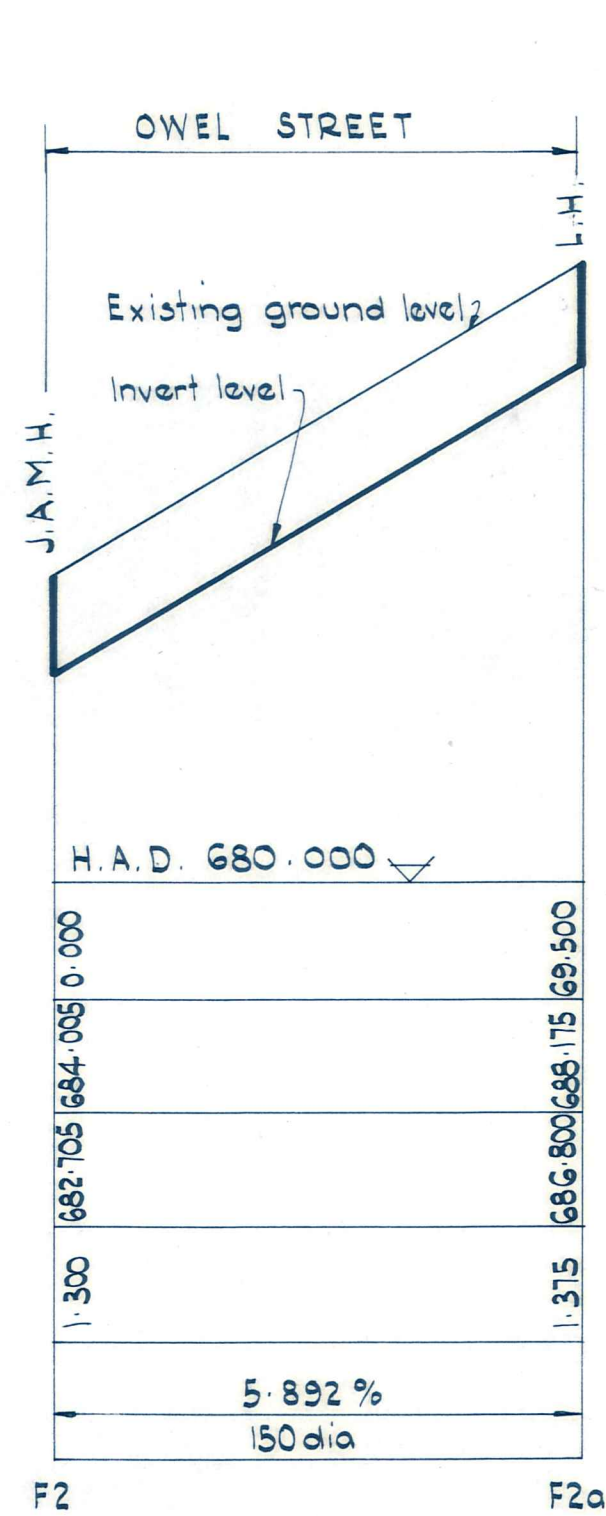

	F2	F2a
DISTANCE		
PEG LEVEL	682.705	686.881
INVERT LEVEL	681.705	689.500
DEPTH TO INVERT	1.000	1.315
GRADE AND DIAMETER		5.892 % 150 dia

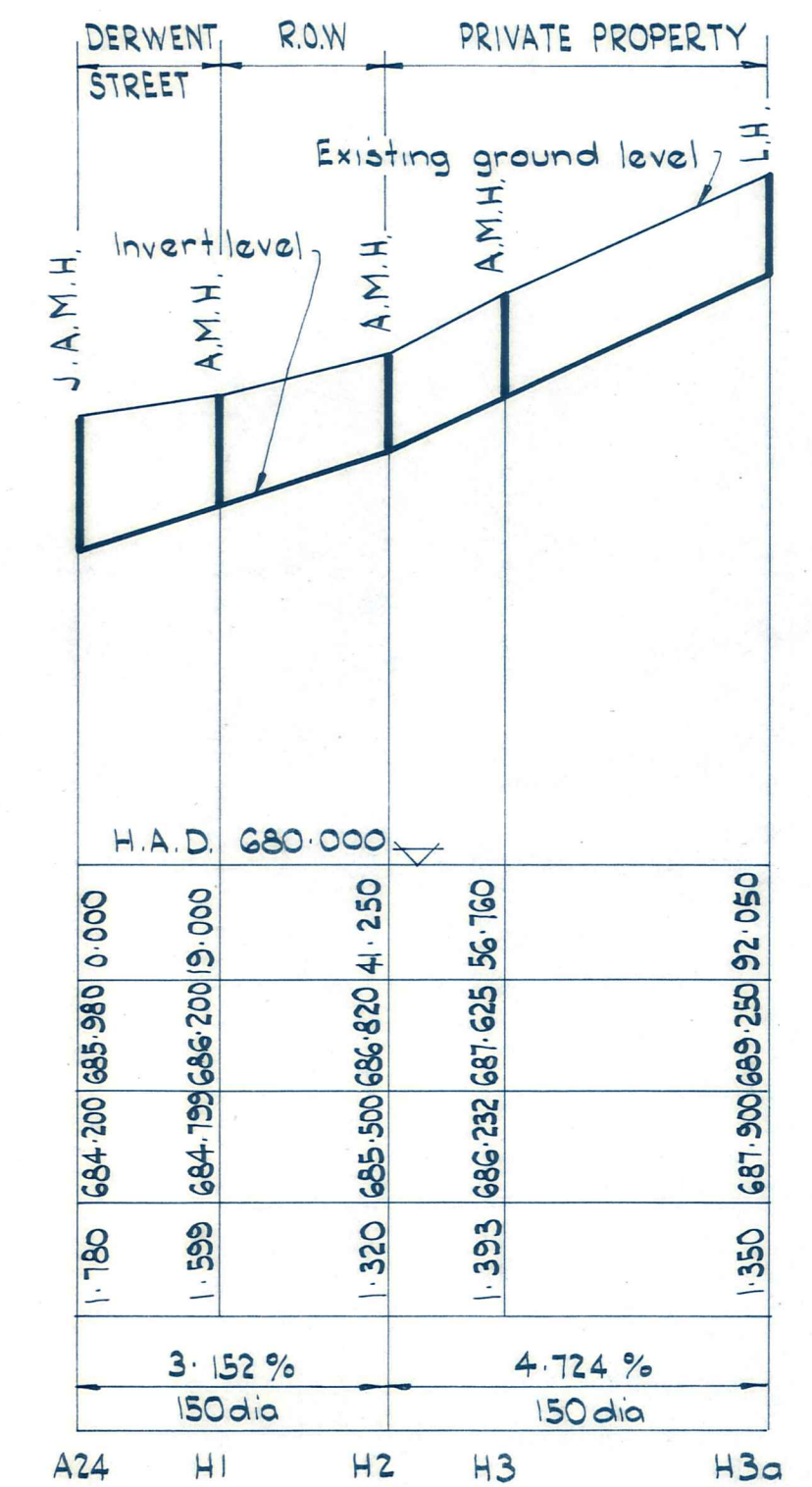

	A24	H1	H2	H3	H3a
DISTANCE					
PEG LEVEL	684.300	684.758	685.500	687.232	687.500
INVERT LEVEL	683.380	684.200	686.420	687.625	689.250
DEPTH TO INVERT	1.180	1.558	1.320	1.393	1.350
GRADE AND DIAMETER		3.152 % 150 dia		4.724 % 150 dia	

PROFILES  
 Scales - Horizontal 1:1000  
 Vertical 1:100

**DUFFILL WATTS & KING LTD**  
 CONSULTING CIVIL & STRUCTURAL ENGINEERS  
 Dundee P.O. Box 5268 Ph. 77-133 Invercargill P.O. Box 576 Ph. 83049  
 Balclutha P.O. Box 220 Phone 1425  
 Cromwell P.O. Box 82 Phone 96

**NASEBY BOROUGH COUNCIL**

**SANITARY SEWERAGE RETICULATION  
 SEWER PROFILES**



DATUM  
 M.S.L.  
 ORIGIN  
 TRIG X

AMENDMENTS			Appvd	Surveyed	NAME	DATE
NO.	BY	DATE			B.T. Kingston	Oct '76
					" "	" "
					" "	" "
					A.H.M. & C.H.	Oct '76
					Checked	
					Approved	

JOB NO.	8 262	Sheet No	11
File	26/3/3	of 18 shts	
L.B.	327	F.B.	



ORIGINAL SIZE  
mm INCHES

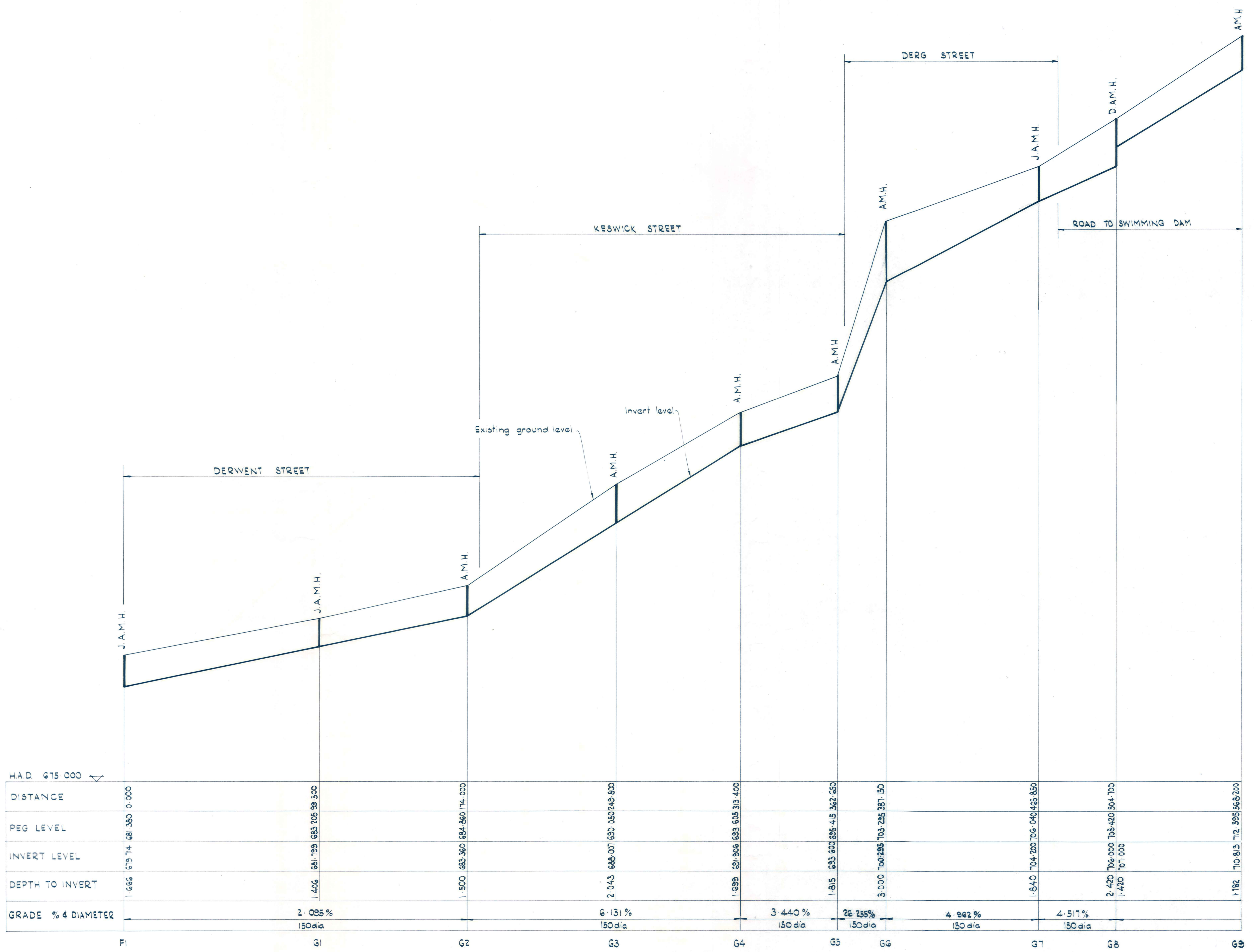

DISTANCE	PEG LEVEL	INVERT LEVEL	DEPTH TO INVERT	GRADE % & DIAMETER
0.000	681.360	679.714	1.646	
1.500	683.205	681.759	1.406	2.025% 150 dia
3.000	684.860	683.360	1.500	
4.500	690.249	688.007	2.043	6.131% 150 dia
6.000	695.400	691.906	3.494	3.440% 150 dia
7.500	702.387	695.415	6.972	26.235% 150 dia
9.000	706.040	703.285	2.755	4.982% 150 dia
10.500	708.420	704.200	4.220	4.517% 150 dia
12.000	712.568	707.000	5.568	

PROFILES  
Scales: Horizontal 1:1000  
Vertical 1:100

**DUFFILL WATTS & KING LTD**  
CONSULTING CIVIL & STRUCTURAL ENGINEERS  
Dunedin P.O. Box 5269 Ph. 77-133 Invercargill P.O. Box 576 Ph. 83049  
Balclutha P.O. Box 220 Phone 1425  
Cromwell P.O. Box 82 Phone 96

**NASEBY BOROUGH COUNCIL**

**SANITARY SEWERAGE RETICULATION  
SEWER PROFILES**



DATUM  
M.S.L.  
ORIGIN  
TRIG X

AMENDMENTS			NAME	DATE
NO.	BY	DATE		

Appvd.	Surveyed	B.T. Kinaston	Oct '76
	Drawn	"	"
	Calculations	"	"
	Traced	A.H.M. & C.H.	Oct '76
	Checked		
	Approved	<i>Hambleton</i>	Dec '76

JOB NO.	Sheet No
8 262	12
	of 18 sheets
File 26/3/3	L.B. 326
	F.B. 327



ORIGINAL SIZE INCHES

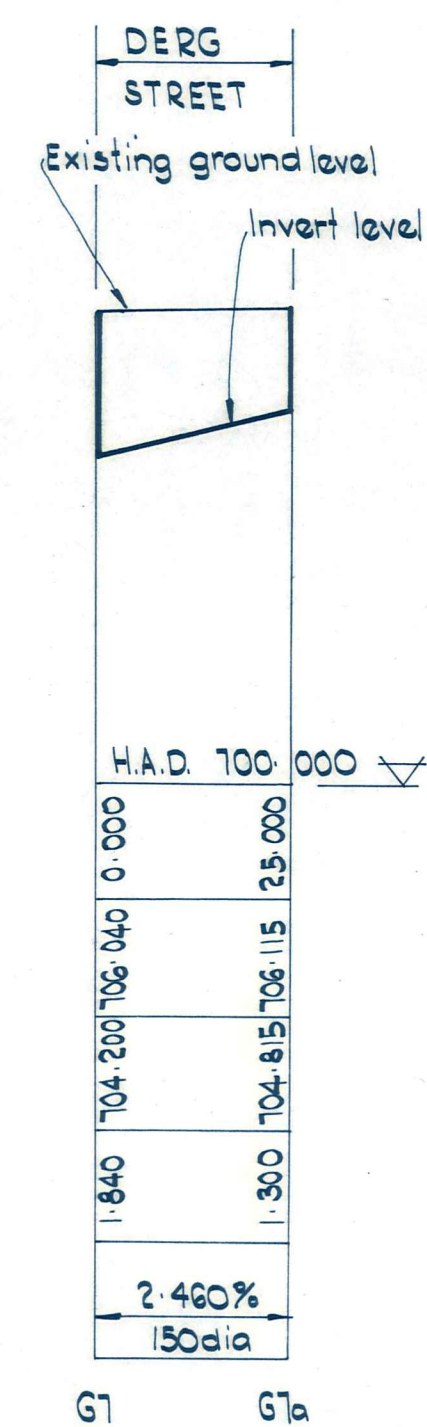
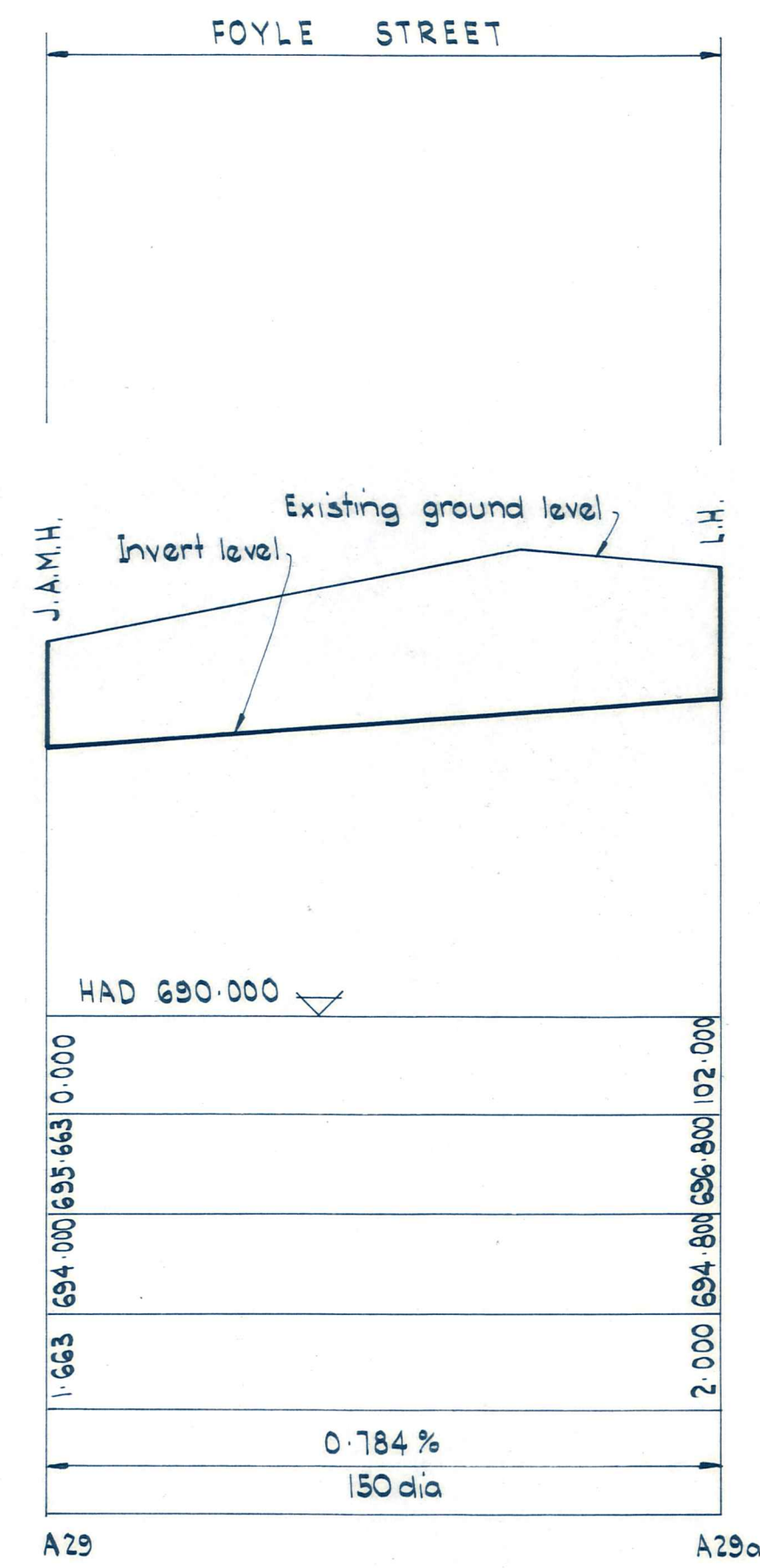
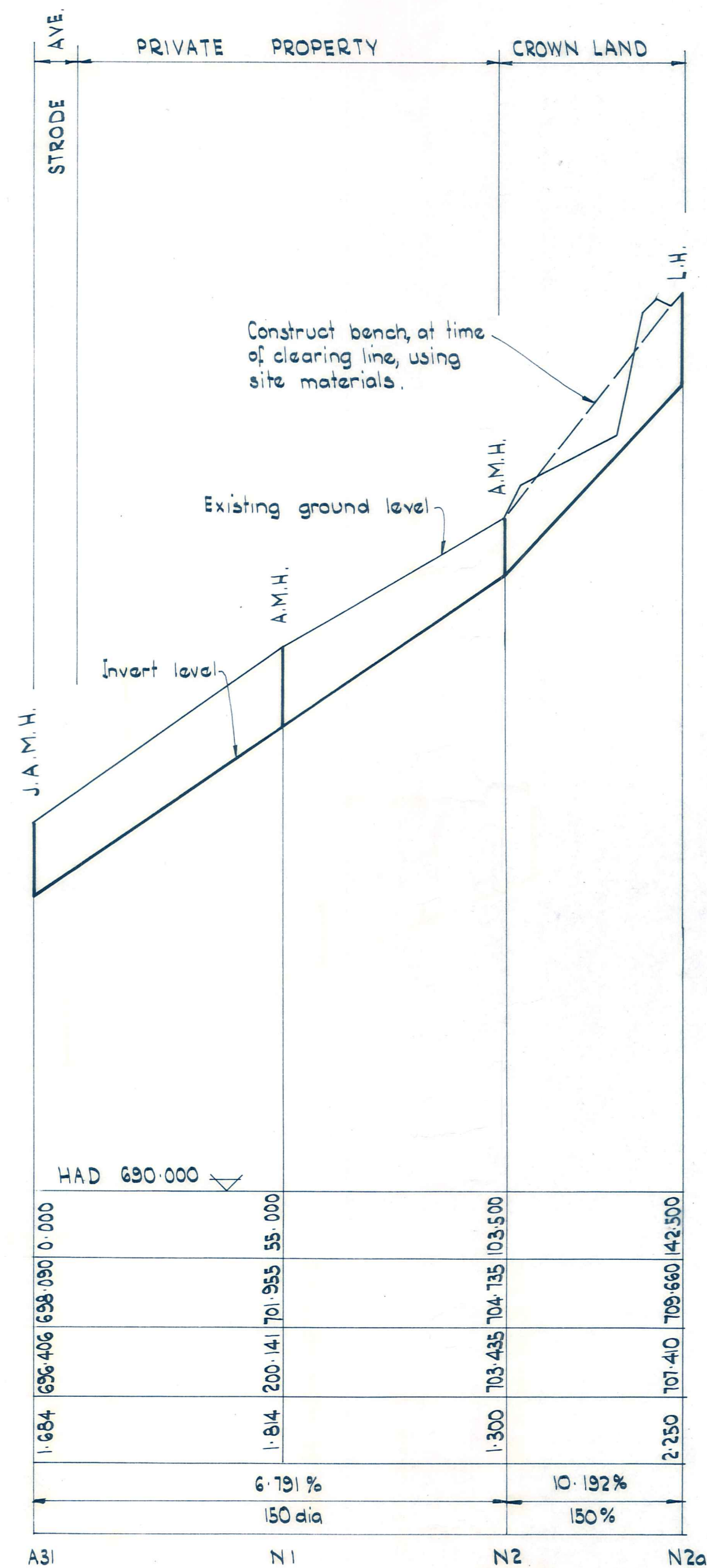
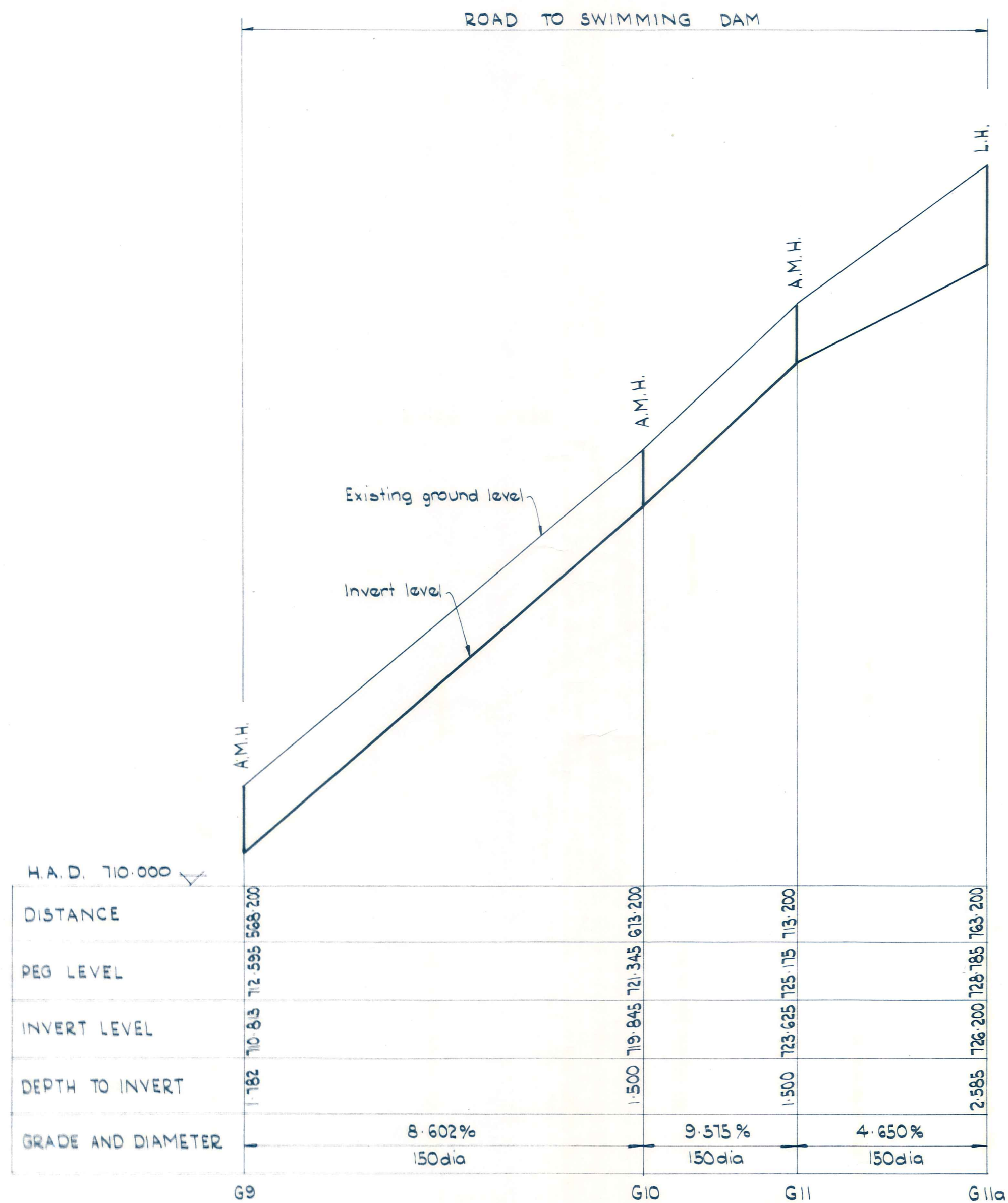

PROFILES

Scales - Horizontal 1:1000  
Vertical 1:100

DUFFILL WATTS & KING LTD  
CONSULTING CIVIL & STRUCTURAL ENGINEERS  
Dunedin P.O. Box 5269 Ph. 77-133 Invercargill P.O. Box 576 Ph. 83049  
Balclutha P.O. Box 220 Phone 1425  
Cromwell P.O. Box 82 Phone 96

NASEBY  
BOROUGH  
COUNCIL

SANITARY SEWERAGE RETICULATION  
SEWER PROFILES



DATUM  
M.S.L.  
ORIGIN  
TRIG X

AMENDMENTS			NAME DATE	
NO.	BY	DATE	Appvd.	Surveyed
				B. T. Kinaston Oct '76
				Drawn
				Calculations
				Traced
				A. H. Moore Oct '76
				Checked
				Approved

File 26/3/3  
L.B. 326  
327

JOB NO.  
8262  
Sheet No  
13  
of 18 shts  
F.B.



ORIGINAL SIZE INCHES

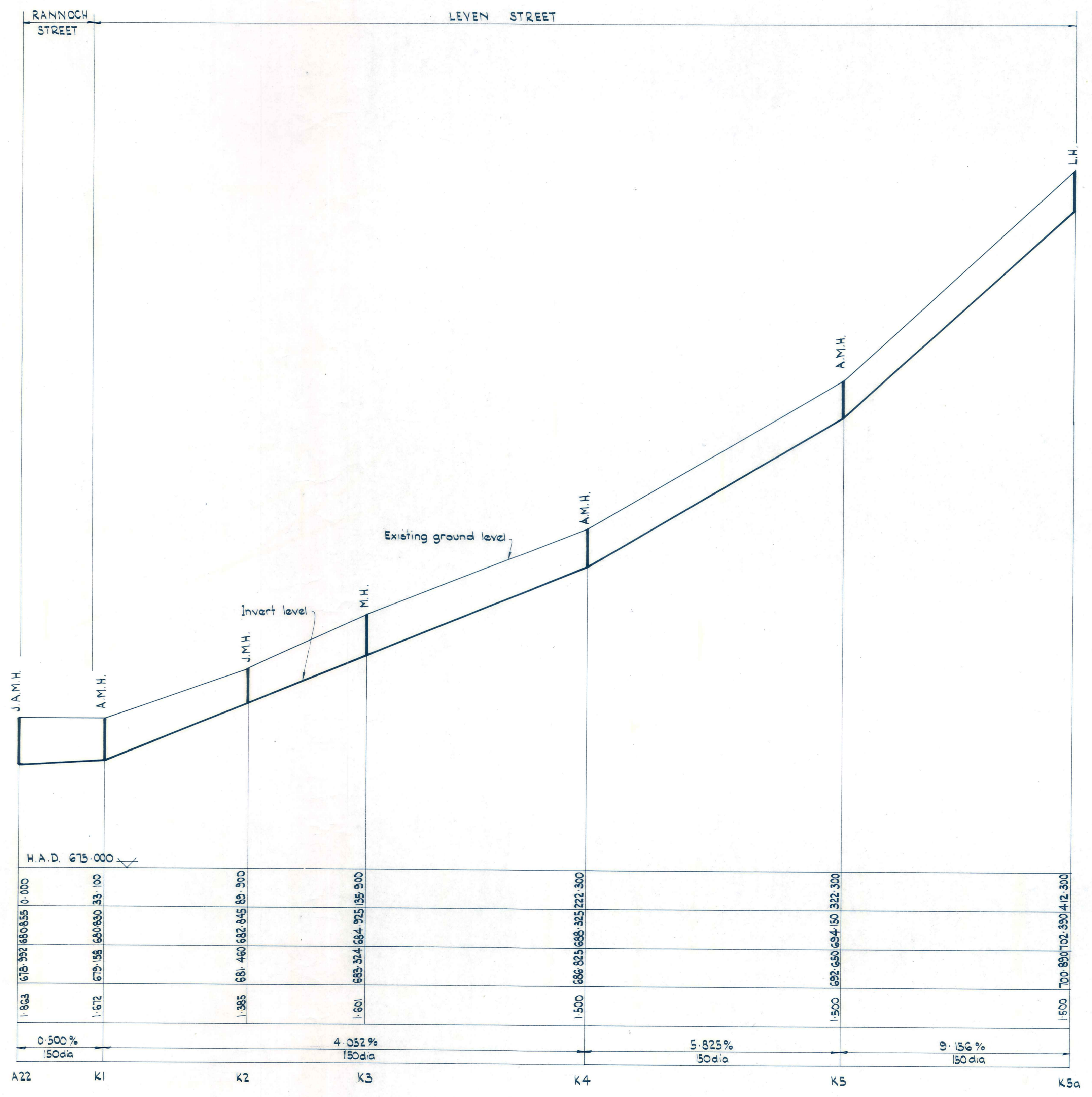
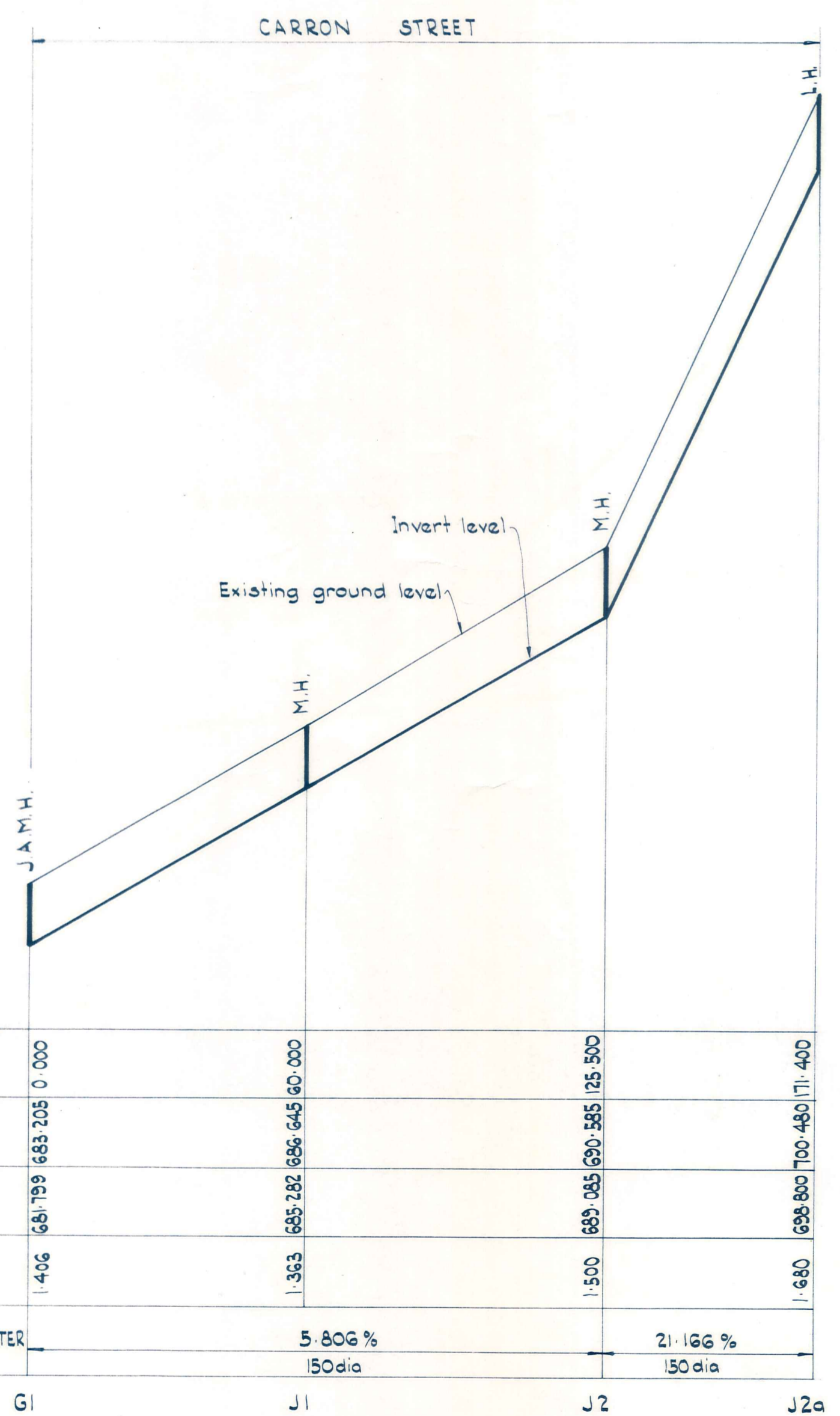

PROFILES

Scales Horizontal 1:1000  
Vertical 1:100

**DUFFILL WATTS & KING LTD**  
CONSULTING CIVIL & STRUCTURAL ENGINEERS  
Dunedin P.O. Box 5269 Ph. 77-133 Invercargill P.O. Box 576 Ph. 83049  
Balclutha P.O. Box 220 Phone 1425  
Cromwell P.O. Box 82 Phone 96

**NASEBY BOROUGH COUNCIL**

**SANITARY SEWERAGE RETICULATION  
SEWER PROFILES**



DATUM  
M.S.L.  
ORIGIN  
TRIG X

AMENDMENTS			NO.	BY	DATE	Appvd.

NAME	DATE
B.T. Kinaston	Oct '76
"	"
A.H.M. & CH.	Oct '76
Shambhala	Dec '76

JOB NO.	8 262	Sheet No.	14
File	26/3/3	L.B.	326 327
F.B.			



ORIGINAL SIZE mm INCHES

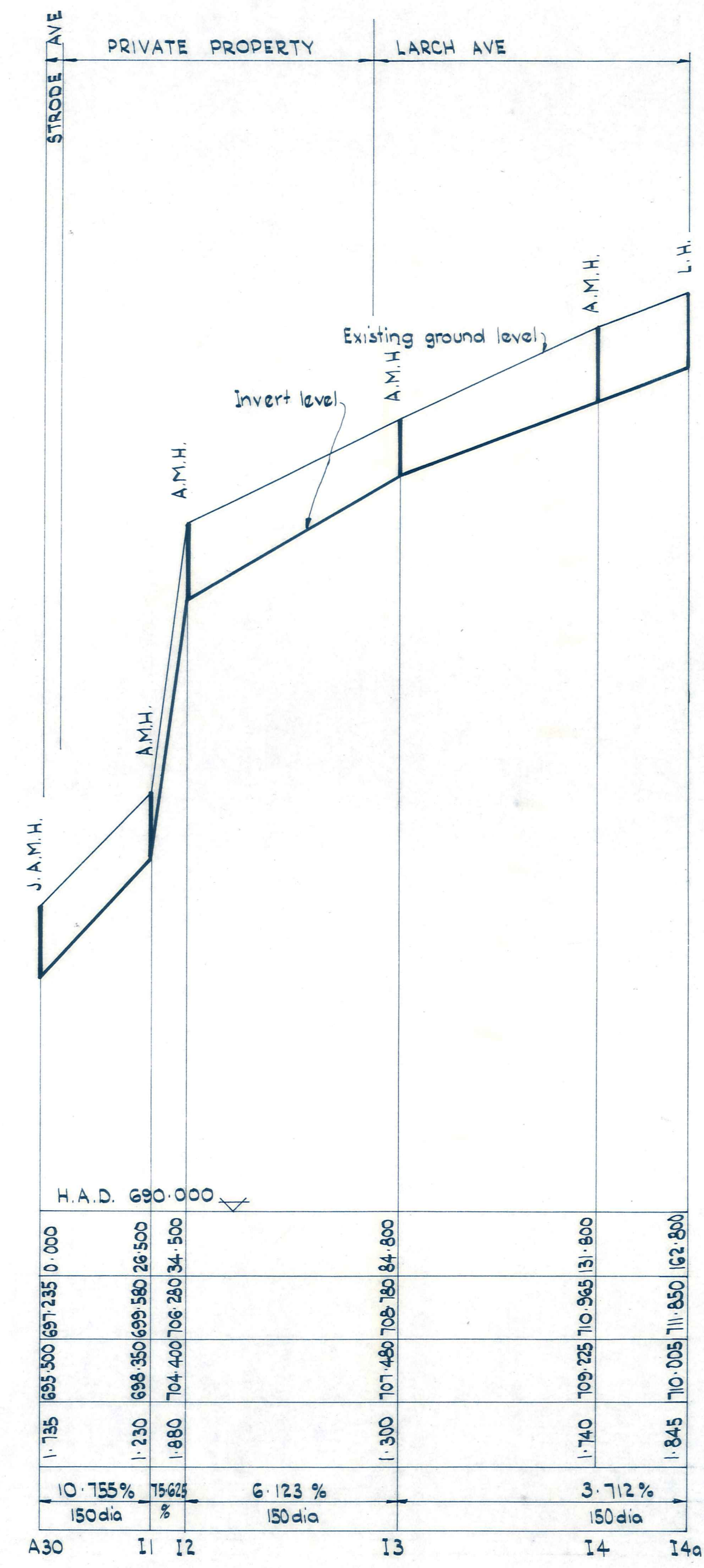
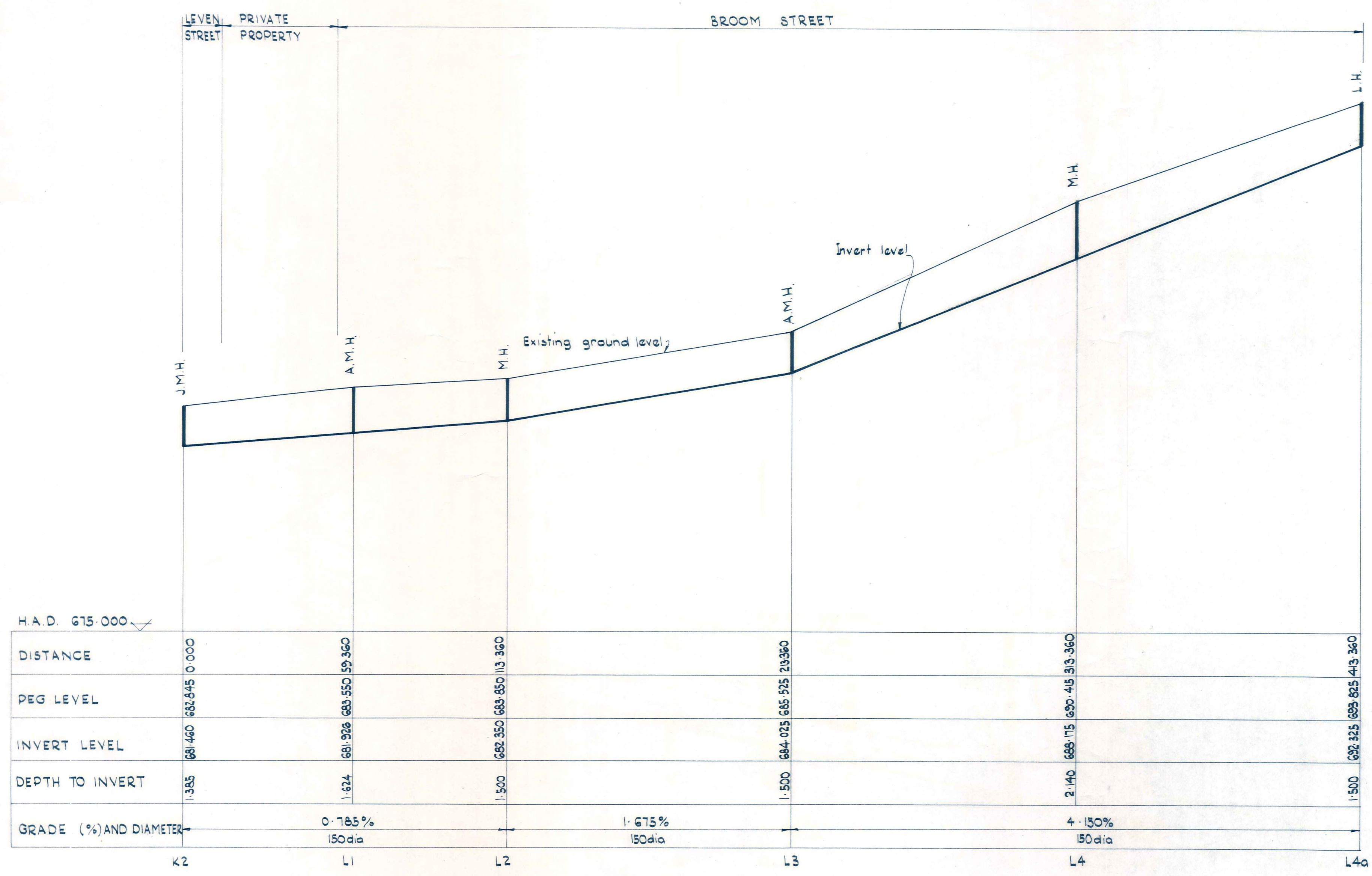

PROFILES  
 Scales - Horizontal 1:1000  
 Vertical 1:100

DUFFILL WATTS & KING LTD  
 CONSULTING CIVIL & STRUCTURAL ENGINEERS  
 Dunedin P.O. Box 5269 Ph. 77-133 Invercargill P.O. Box 576 Ph. 83049  
 Balclutha P.O. Box 220 Phone 1425  
 Cromwell P.O. Box 82 Phone 96

NASEBY  
 BOROUGH  
 COUNCIL

SANITARY SEWERAGE RETICULATION  
 SEWER PROFILES

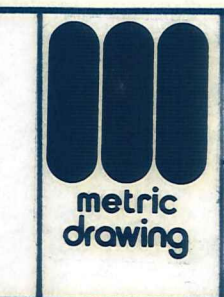

DATUM  
 M.S.L.  
 ORIGIN  
 TRIG X

AMENDMENTS			
NO.	BY	DATE	Appvd.

NAME	DATE
B.T. Kinaston	Oct '76
"	"
A.H.M. & C.H.	Oct '76
"	Dec '76

JOB NO.	8 2 6 2	Sheet No	15
File	26/3/3	L.B.	326 327
F.B.			



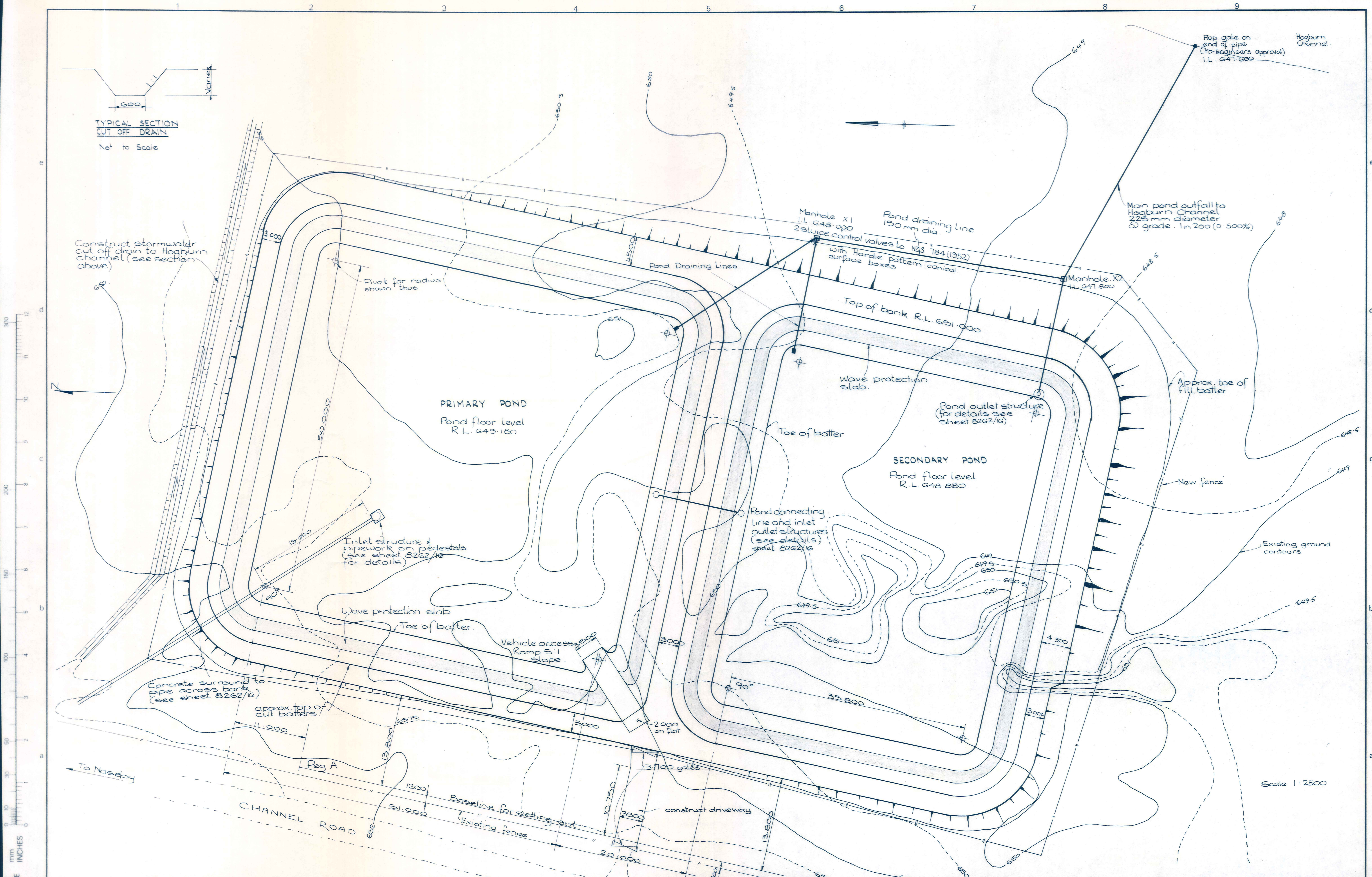

**TYPICAL SECTION  
CUT OFF DRAIN**  
Not to Scale

ORIGINAL SIZE  
mm INCHES

**DUFFILL WATTS & KING LTD**  
CONSULTING CIVIL & STRUCTURAL ENGINEERS  
Dunedin P.O. Box 5289 Ph. 77-133 Invercargill P.O. Box 576 Ph. 83049  
Balclutha P.O. Box 220 Phone 1425  
Cromwell P.O. Box 82 Phone 96

**NASEBY  
BOROUGH  
COUNCIL**

**SEWAGE TREATMENT  
OXIDATION POND LAYOUT**



**DATUM**  
M.S.L.  
**ORIGIN**  
TRIG X

AMENDMENTS			
NO.	BY	DATE	Appvd.

NAME	DATE
Surveyed B.T. Kinaston	Oct '76
Drawn G.R. Gillespie	Oct '76
Calculations " "	" "
Traced M.E. Gill	Oct '76
Checked " "	" "
Approved " "	Dec '76

<b>JOB NO.</b>	<b>Sheet No</b>
8262	16
File 2G/3/3 L.B. 327	of 18 shts
F.B.	



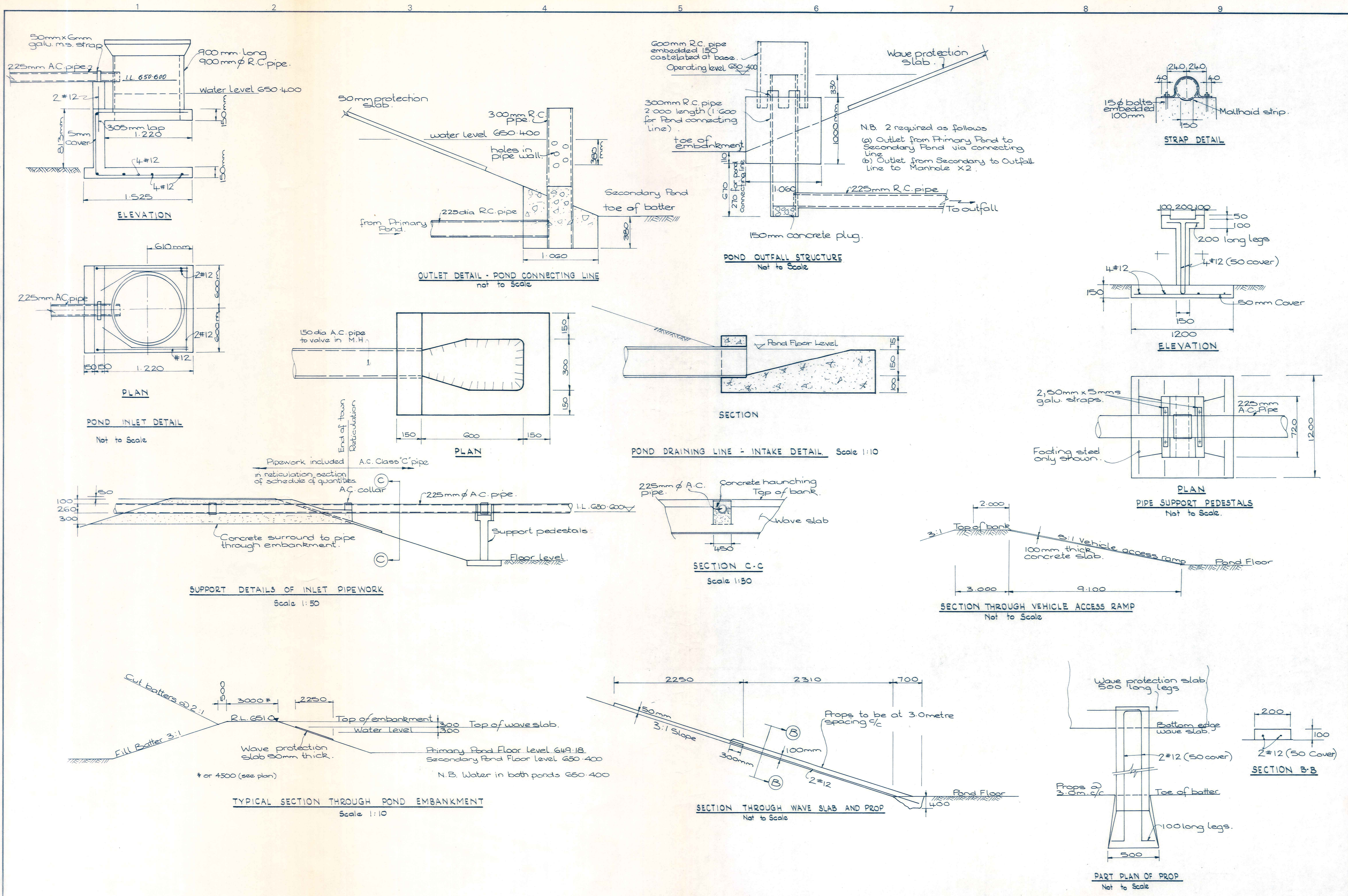

**DUFFILL WATTS & KING LTD**  
 CONSULTING CIVIL & STRUCTURAL ENGINEERS  
 Dundee P.O. Box 5269 Ph 77.133 Invercargill P.O. Box 576 Ph 83049  
 Raletuha P.O. Box 220 Phone 1425  
 Cromwell P.O. Box 82 Phone 96

**NASEBY BOROUGH COUNCIL**

**SEWAGE TREATMENT POND LAYOUT**



**DATUM**  
 M.S.L.  
**ORIGIN**  
 TRIG X

AMENDMENTS		
NO.	BY	DATE

NAME	DATE
Surveyed B.T. Kinaston	Oct '76
Drawn G.R. Gillespie	"
Calculations " "	"
Traced M.E. Gill	Oct '76
Checked " "	"
Approved Chamberlain	Dec '76

JOB NO.	8262	Sheet No	17
File 26/3/3	L.B. 326	F.B.	317
of 18 sheets			



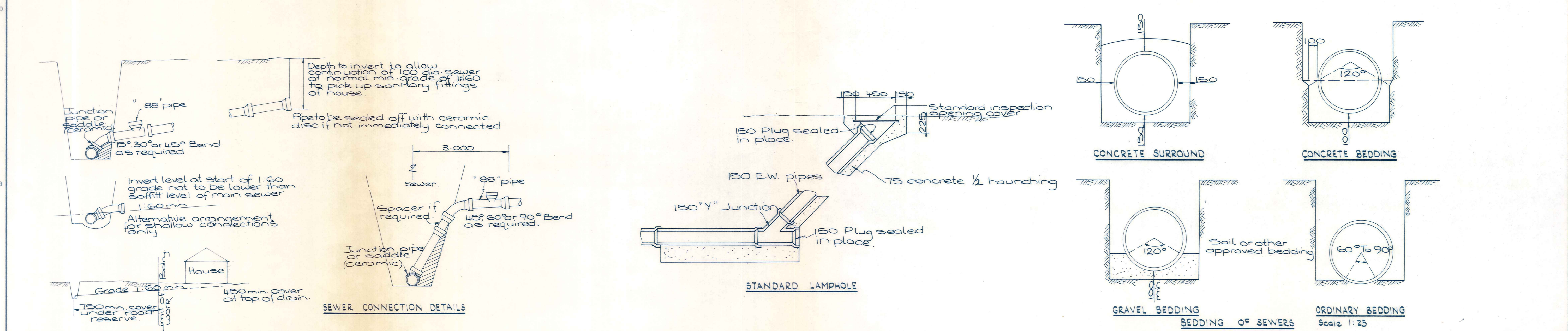
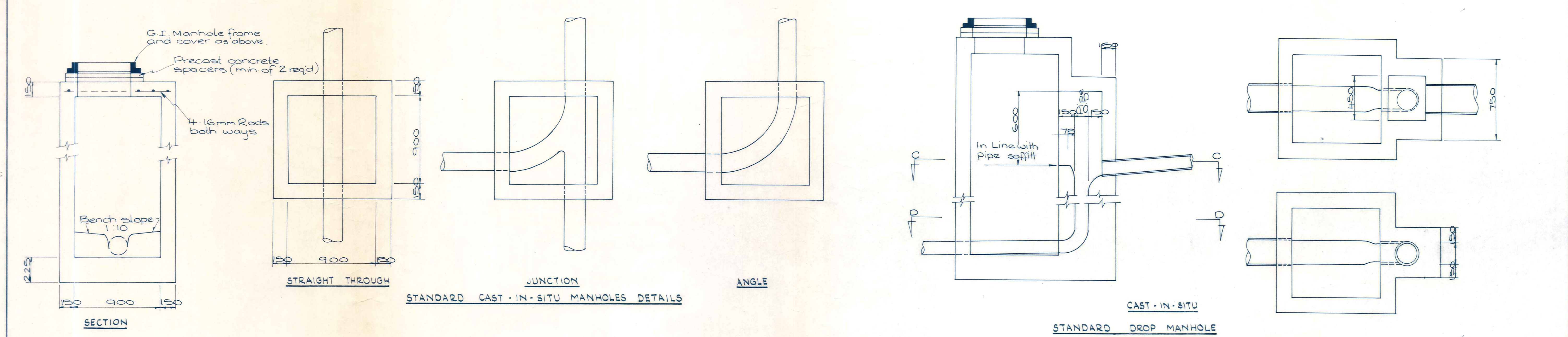
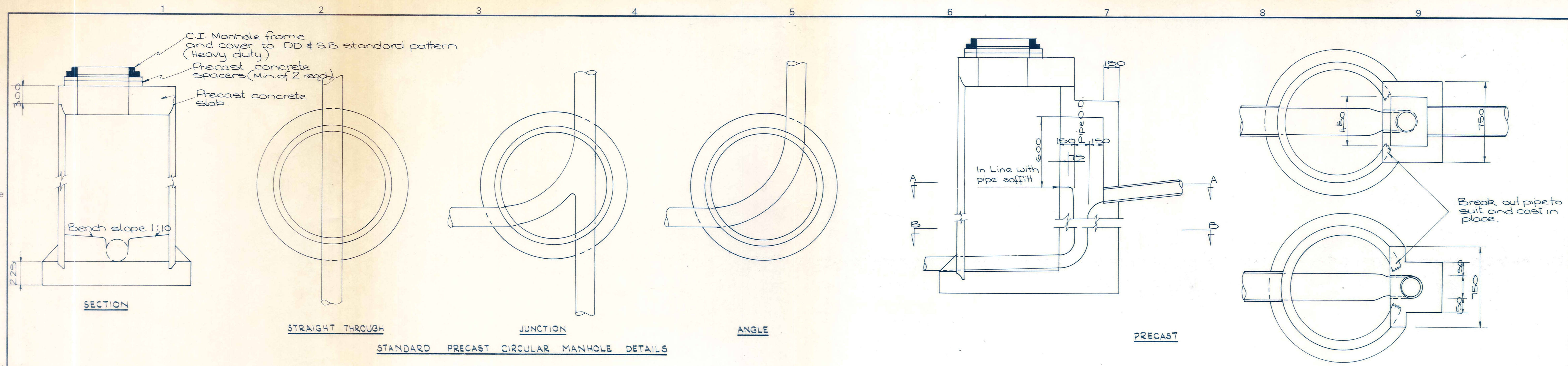

ORIGINAL SIZE INCHES

mm

0 10 20 30 40 50 60 70 80 90 100 150 200 300

**DUFFILL WATTS & KING LTD**  
 CONSULTING CIVIL & STRUCTURAL ENGINEERS  
 Dundee P.O. Box 5269 Ph. 77-133 Invercargill P.O. Box 576 Ph. 83049  
 Balclutha P.O. Box 220 Phone 1425  
 Cromwell P.O. Box 82 Phone 98

**NASEBY BOROUGH COUNCIL**

**SANITARY SEWERAGE RETICULATION  
 STANDARD PIPEWORK DETAILS**

**metric drawing**

**DATUM**  
M.S.L.  
**ORIGIN**  
TRIG X

AMENDMENTS			NAME	DATE
NO.	BY	DATE		

Surveyed	B.T. Kingston	Oct '76
Drawn	G.R. Gillespie	"
Calculations		
Traced	M.E. Gill	Oct. '76
Checked		
Approved	Chamberlain	Dec '76

JOB NO.	8262	Sheet No	18
of 18 shts			
File 26/3/3	LB 326	F.B.	327